

WELL ORGANISED

Thanks to the wide range of combination options, each workstation can be individually equipped with LISTA workbenches to optimise space. The combinable workbench tops, drawer cabinets, power unit cabinets, vices and rear panels can be organised to create optimum working conditions. The latest findings in ergonomics are incorporated and everything is delivered to the highest LISTA quality even for the most demanding working environments in workshops and heavy industry.



The right solution for every need



move workstations
see p. 110



Workbenches
see p. 116



Hexagonal workbenches
see p. 148



Compact workbenches
see p. 150



System workbenches
see p. 152



Assembly trolley
see p. 156



Test and inspection workstations
see p. 158

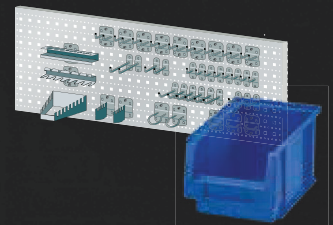

Storage containers and keyhole hooks
see p. 162



Desk chairs
see p. 164

+ The utmost stability
Workbench load capacity up to 3 t, workbench tops extremely robust and resistant

+ Great design diversity
thanks to the wide range of components, substructures, materials and surfaces

+ Ergonomics and health
with height-adjustable workbench legs for optimum working heights and leg room – also available for our modular superstructure system

+ Easily adaptable to new working environments
Flexible integration and reconfiguration of all components in the modular system

+ Fully mobile
when fitted with rubber or nylon castors for mobile use

+ move workstation system
electrically height-adjustable workstations with load capacities of 300–400 kg for a wide range of requirements and applications, see p. 110–115

+ Fast and easy assembly
thanks to countertops with pre-assembly (incl. threaded inserts and bolts) for fastening all substructures and drawer cabinets

>> General benefits of the LISTA drawer cabinets
See p.38/39

Three into one

Whether heavy duty or the assembly area - with the LISTA workstation system you can configure the solution that suits all your tasks and requirements. This works according to a very simple principle. Each workstation is comprised of three main elements: substructure, universal superstructures and worktops. These can be individually equipped and expanded to provide total flexibility.



1 Substructures

Depending on the application and area of application, you can choose between substructures in four variants.

From p. 112



Move workstation frame in H design, electrically adjustable



Move workstation foot in H design, electrically adjustable



Move workstation frame in C design, height-adjustable



Workbench leg assembly, fixed or height-adjustable



3 Universal superstructures

Combine substructures and worktops freely and flexibly with the universal superstructures of the LISTA system. Numerous modules and accessories are available from the rear panel to the monitor holder.

See p. 132



2 Worktops

The LISTA workstation system offers you a wide range of high-quality worktops:

- Eight standard materials for every purpose
 - Six standard widths and five standard depths
- Other plate types and dimensions on request.

See p. 124

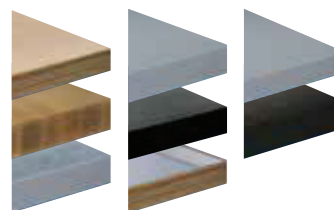

1 move workstation system

LISTA's workstation system range offers an all-in-one solution for optimising workstations and workflows. Regardless of whether it's an individual table, multiple workstations or a team environment: the seamless integration of components turns simple workstations into functional system solutions for optimum ergonomics and cost-effectiveness.

+ Utmost stability

up to 300 kg (move C design) or 400 kg (move H design) weight loading, H design is characterised by maximum rigidity

+ User-friendly and ergonomic

freely variable electrical height adjustment with workstation frames (H or C design) or workstation feet (H design). Programmable control for storing table heights

+ Space-saving and well-organised storage

in freely combinable and configurable LISTA drawer cabinets

+ Perfect cable management

thanks to cable trays and cable guide clip

+ Fully mobile

when fitted with rubber or nylon castors for mobile use

>> Universal superstructures

see p. 132

>> Desk chairs

see p. 164–167

>> General benefits of the LISTA drawer cabinets

see p. 38/39

+ Benefits of ergonomic workstation design



» Desk chairs see p. 164–167

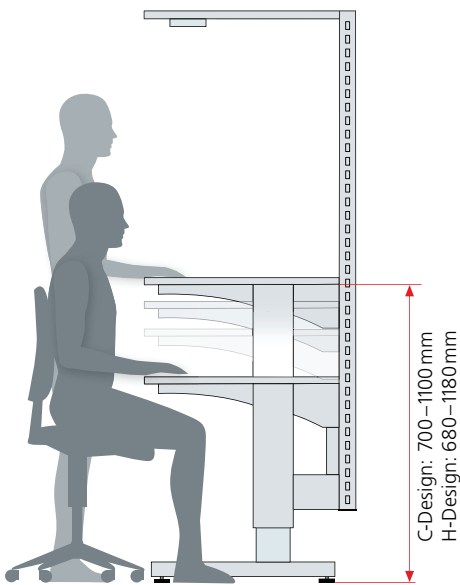

- Simplified workflows resulting in quality improvements and a reduction in error rates
- 20% increased efficiency
- Increased performance potential and reduced processing times
- Healthier work environment and cost reduction in the long term thanks to fewer disruptions

Optimum reach area

Based on average human body dimensions, there are four access zones on the table worktop with different priorities:

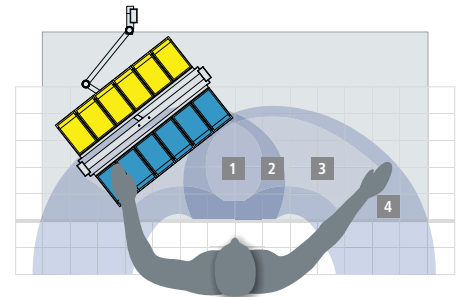

Optimum arrangement of grab containers in zone 2 and 3 right beside the workpiece

- 1 The working centre:**
Both hands work in the direct field of vision
- 2 Extended working centre:**
Both hands reach all areas of this zone
- 3 One-hand zone:**
Parts and tools are within easy reach of one hand
- 4 Extended one-hand zone:**
Outermost usable zone

Mobility – humans as a standard

Assembly workstations should be fundamentally designed for sitting as well as standing positions. If alternating between sitting and standing positions is not possible, a sitting position is preferable.

Features

	move H design		move C design
	H frame	H leg	C frame
Load capacity	400 kg	400 kg	300 kg
Adjustment range (without top)	680–1180 mm	680–1180 mm	700–1100 mm
Workbench depth	800/1000 mm	750–1000 mm	620–800 mm
Rigidity in the front countertop area	++	++	+
Knee clearance	+	+	++
Countertop thickness	30 mm	40/50 mm	30 mm
Countertop widths	1000/1500/2000	flexible up to 2500*	1200/1500/2000

*The max. top width depends on the load capacity. For load capacities see p. 130/131.

Lighting

Good lighting helps to reduce error rates caused by overstrained eyes. Employee performance and production quality rise. The required light intensity must be adapted to the assembly activities.

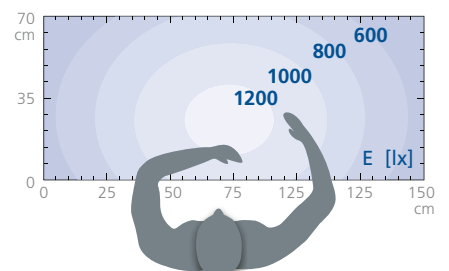

Substructures

Does your workstation require a particularly stable and robust substructure, and must it be accessible or easily height-adjustable? The LISTA workstation system has flexible and configurable modules in four variants tailored to the requirements of different areas of application. In addition to the two electrically adjustable LISTA move H design workstation frames and legs, our system also includes the C design of the movable workstation frame, which is especially suitable for assembly and control tasks, as well as the classic workbench leg assembly for high loads in workshops and production.

move workstation frame, H design, electrically height-adjustable



4-legged tubular construction incl. connection for universal superstructures and adjustable legs. Lifting force: Max. 400 kg with evenly distributed load. Lift: 500 mm. Max. speed 23 mm/s. Incl. control and operating unit. Input via system plug. Colour: Lifting unit RAL 9006 white aluminium, outer profile according to colour chart. Without connecting cable. Country-specific connection cable must be ordered separately. See p. 144. Countertop must be ordered with pre-assembly, see page 125. Incl. integrated guide rail for mounting the optional support pillars, see page 138.

W →	D ↗	H ↑	for top W × D mm	Top thickness mm	Art. no.
950	785	680–1180	1000 × 800	30	88.226.XXX
950	985	680–1180	1000 × 1000	30	88.227.XXX
1450	785	680–1180	1500 × 800	30	88.228.XXX
1450	985	680–1180	1500 × 1000	30	88.229.XXX
1950	785	680–1180	2000 × 800	30	88.230.XXX
1950	985	680–1180	2000 × 1000	30	88.231.XXX

Height without countertop

Reinforcement angle for move workstation frame, H design

For mounting on the workbench top and reinforcing the guide rails to withstand high loads..
D × H: 190 × 272 mm Colour: as per colour chart.



Fastening bracket

Art. no.

88.237.XXX

Suspension adapter for hanging drawer cabinets

Can be mounted either on the left or right underneath the countertop. Model: sheet steel.
Colour: as per colour chart.

for frame depth mm	width drawer cabinet	depth drawer cabinet	Art. no.
785	18 E	27 E / 36 E	88.238.XXX
785	27 E	27 E / 36 E	88.239.XXX
985	18 E	27 E / 36 E	88.240.XXX
985	27 E	27 E / 36 E	88.241.XXX



Keyboard drawer

Pull-out shelf with rear stop. For H design (frame and leg). W × D: 550 × 370 mm. Max. load: 20 kg. Model: sheet steel. Colour: as per colour chart.

Art. no.

Pull-out keyboard for substructure 550/370

88.242.XXX

Factory assembly

For workstation frame move, H design, with countertop. Without superstructures and base cabinets.

Art. no.

Electrically height-adjustable workstation frame installation

88.246.000

move workstation leg, H design, electrically height-adjustable

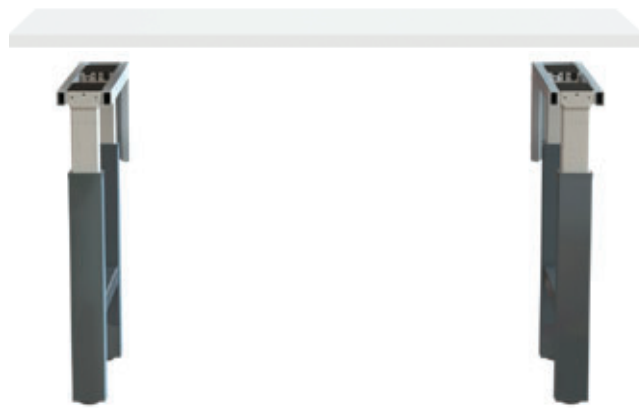

Lifting force: 200 kg/leg with an evenly distributed load. Lift: 500 mm. Speed max. 23 mm/s. Colour: Lifting unit RAL 9006 white aluminium, outer profile according to colour chart. Scope of delivery: 1 unit For your substructure, you need two move work legs, H design, and a 2-fold/4 K control unit. Without connection cable. Country-specific connection cable must be ordered separately, see page 144. Countertop must be ordered with pre-assembly, see page 125. Linking of several legs on request.

W →	D ↗	H ↑	for top depth mm	Top thickness mm	Art. no.
90*	725	680–1180**	750/800	40–50	88.200.XXX
90*	925	680–1180**	1000	40–50	88.201.XXX

*Corresponds to leg width (max. width 175 mm) **Height without countertop



Convenient operating element

Display of table height. Four favourite positions can be saved. Manual height storage.

Art. no.
88.203.000

Convenient operating element



Control unit two-fold/4K

Complete set incl. basic control elements (up/down control), cable guide chain and connection cable between control unit and motors. For controlling the move workstation leg, H design. Mains voltage 100 – 240 V AC, 50–60Hz, IP20, overload protection, soft start/stop function, connection via Wieland system plug, colour: black

Art. no.
88.202.000

Control unit set 2-fold/4K



Cross brace for shelves

Including fastening material. Model: sheet steel. Colour: as per colour chart. Scope of delivery: 1 unit

for top width (2 legs) mm	for leg distance (centre) mm	Strut length mm	Art. no.
1500	1300	1224	43.233.XXX
2000	1800	1724	43.236.XXX
2500	2300	2224	40.242.XXX



Workstation anti-tilting device

For increasing the tilt protection or securing the workstation. Suitable for H frame and H leg.

H design leg extension 2 profiles

for top depth mm	Art. no.
750/800	88.312.XXX
1000	88.313.XXX



Leg extension incl. castors

For the mobile version of a move workstation in H design, load capacity 300 kg. Suitable for H frame and H leg.

Floor anchoring, galvanised (2 pcs.)

88.314.000

Leg extension incl. push handle and castors*

2 leg extensions	750/800	Art. no.
4 double castors (Ø 80 mm, steerable with 2 brakes)	1000	88.311.XXX

* Increases table height by approx.



Multiplex/synthetic resin storage shelf

Suitable for attachment between two move workbench legs, H design. Capacity 20 kg. Including fastening material.

Multiplex 20 mm

for top width mm	W →	D ↗	H ↑	for depth workbench leg move mm	Art. no.
1500	1420	520	20	725	88.213.000
2000	1920	520	20	725	88.214.000
1500	1420	720	20	925	88.216.000
2000	1920	720	20	925	88.217.000
Special size (max. W × D: 2500 × 1250 mm)					88.218.000

Resin 22 mm

for top width mm	W →	D ↗	H ↑	for depth workbench leg move mm	Art. no.
1500	1420	520	22	725	88.220.000
2000	1920	520	22	725	88.221.000
1500	1420	720	22	925	88.223.000
2000	1920	720	22	925	88.224.000
Special size (max. W × D: 2740 × 1200 mm)					88.225.000



move workstation frame, C design

**With clamping screws**

Table legs height-adjustable using clamping screws. For top thickness: 30 mm.

W →	D ↗	H ↑	for top depth mm	for top width mm	Art. no.
1030	600	700–1100	620–800	1200	65.300.XXX
1360	600	700–1100	620–800	1500	65.301.XXX
1780	600	700–1100	620–800	2000	65.302.XXX

Height without countertop

**With electric motor**

Table substructure can be electrically adjusted to any height. The operating unit can be mounted on the left or right (on the right as standard). A connection cable is required for operation, see p. 144. For top thickness: 30 mm.

W →	D ↗	H ↑	for top depth mm	for top width mm	Art. no.
1030	600	700–1100	620–800	1200	65.204.XXX
1360	600	700–1100	620–800	1500	65.205.XXX
1780	600	700–1100	620–800	2000	65.206.XXX

Height without countertop

Programmable control system

Optionally available for automatic adjustment of individual installation heights



Programmable control system

Art. no.
65.232.000

**With hand crank**

Table substructure can be mechanically adjusted to any height with the hand crank. The hand crank is removable (can be mounted on the left or right). For top thickness: 30 mm.

W →	D ↗	H ↑	for top depth mm	for top width mm	Art. no.
1030	600	700–1100	620–800	1200	65.303.XXX
1360	600	700–1100	620–800	1500	65.304.XXX
1780	600	700–1100	620–800	2000	65.305.XXX

Height without countertop

**Caster set C design**

For fastening to existing move workstation frame, C design. Designed as temporary roll support to move the workstation quickly and effortlessly. Adjustment range downwards reduced by approx. 25 mm. Incl. push handle.

Fixed Table
(castors up)

Mobile Table
(castors down)

Caster set	Art. no.
	74.991.000

Accessories

W →	D ↗	H ↑	Art. no.
Pull-out keyboard drawer for table frame			
Load: 20 kg Drawer width: 520 mm.			
560	420	75	65.297.XXX

PC compartment

Mounting on bench frame. Do not exceed max. PC height: 500 mm.

76	410	40	65.144.XXX
----	-----	----	-------------------

Bracket

Bracket 18 × 27 E for fastening the drawer cabinets to either the left or the right of the table frame. Specification: sheet steel. Colour: as per colour chart. Drawer cabinets 18 × 27 E, see p. 46 onwards.

411	-	-	65.074.XXX
-----	---	---	-------------------

! Caution

The maximum load for the H design as well as for the C design applies with an evenly distributed load (incl. countertop and add-on elements).

move workstation planning information

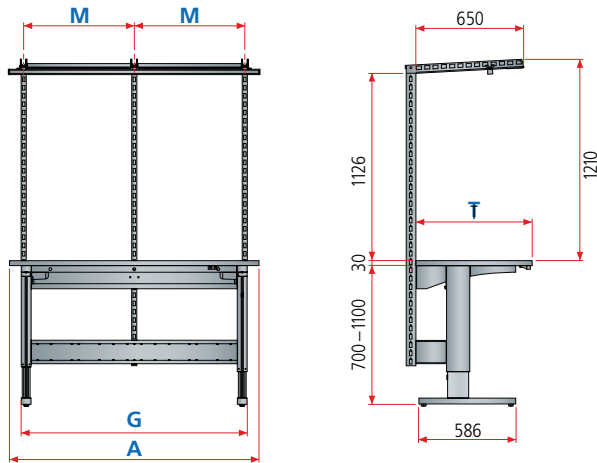

Workstation frame, C design				
Worktop width mm	A	1200	1500	2000
Worktop depth mm	T	700	700	700
Table frame width mm*	G	1030	1360	1780
Possible module widths mm	M	s.p. 136	s.p. 136	s.p. 136
Max. superstructure module widths mm	M	1000	1330	1665

* Dimension G = Exterior side of support to exterior side of support

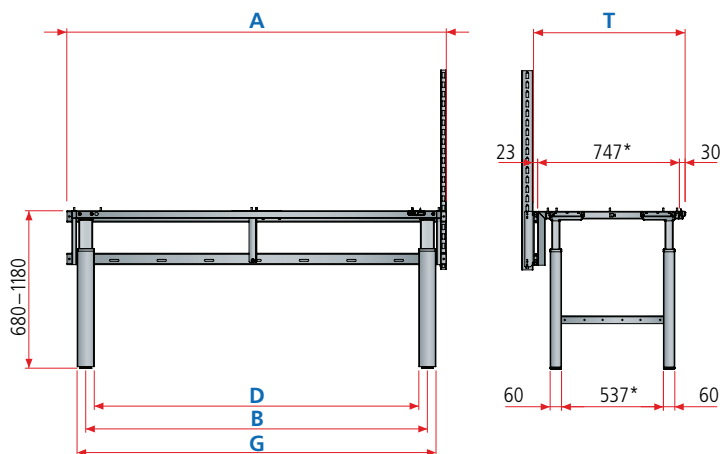

Workstation frame, H design				
Worktop width mm	A	1000	1500	2000
Worktop depth mm	T	800/1000	800/1000	800/1000
Table frame width mm*	G	950	1450	1950
Number of leg assemblies		2	2	2
Width between supports mm	B	800	1300	1800
Storage shelf		920	1420	1910
Clear width mm	D	710	1210	1710
Clear crossbeam width mm		720	1220	1720

* when using a top depth of 800 mm

**without guide rail

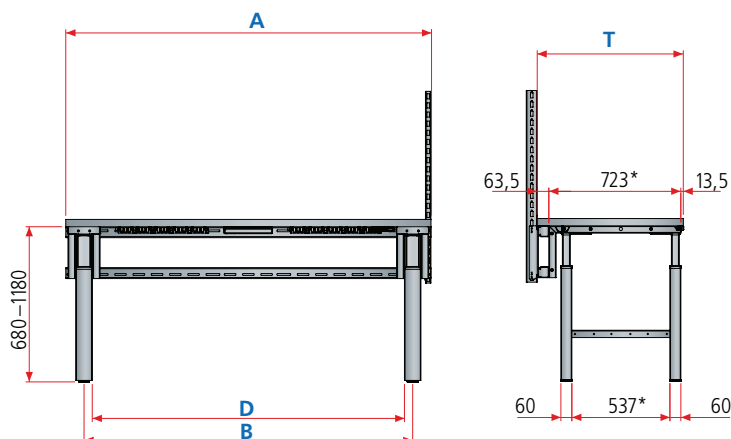

Workstation frame, H design						
Worktop width mm	A	1000	1500	2000	2500	3000
Worktop depth mm	T	800/1000	800/1000	800/1000	800/1000	800/1000
Number of leg assemblies		2	2	2	2	3
Width between supports mm	B		1300	1800	2300	1400
Storage shelf			1420	1920	2420	2 x 1460
Clear width mm	D		1210	1710	2210	1310
Clear crossbeam width mm			1220	1720	2220	1320

* when 800 mm top depth is used



1 Workbenches

Thanks to the wide range of combination options, each workstation can be individually equipped with LISTA workbenches to optimise space. The combinable workbench tops, drawers and equipment cabinets, vices and rear panels can be organised to create optimum working conditions. The latest findings in ergonomics are incorporated and everything is delivered to the highest LISTA quality even for the most demanding working environments in workshops and heavy industry.

+ Utmost stability

workbench load capacity up to 3 t, workbench top extremely robust and resistant

+ Easy to use and highly ergonomic

with height-adjustable workbench legs for optimum working heights and leg room – also available for our modular superstructure system

+ Fully mobile

when fitted with rubber or nylon castors for mobile use

+ Fast and easy assembly

as the workbench tops have pre-drilled holes including threaded inserts (pre-assembled) for fastening all substructures and drawer cabinets

>> Universal superstructures

see p. 132

>> Benefits of LISTA drawer cabinets

see p. 38/39

>> Desk chairs

see p. 164–167

+ Various substructures



Workbench legs

- sturdy steel plate construction
- welded from steel profiles
- with holes for attaching worktops and shelves



Castors for mobility

- for mobile workbenches
- fixed castors and swivel castors including brake mechanisms
- nylon or rubber-coated wheels for soft and hard floors



Vice cabinet

- can be fitted with any desired vice
- can easily be folded away beneath the workbench



Power unit and drawer cabinets

- prepared for the installation of the power and air supply by the customer at the workstation

» For order information, please contact us.

Order preconfigured models

» Pages 118–120

» Page 132

1. Select workbench

2. Substructure accessories

3. Superstructures and accessories

... or configure and order workbenches individually

» Pages 124–129

» Page 132

1. Workbench top

- Select size and material of workbench top
- 5 different materials with various dimensions are available
- When assembling preconfigured workbenches, additional fastening materials and threaded inserts (pre-assembled) must be ordered for each component.

2. Top accessories

- Select worktop accessories
- Select from items such as rear panels and side panels, storage shelves, fastening material and pre-assemblies

3. Substructures and accessories

- Select the substructure
- You can select from workbench leg assemblies and drawer cabinets in various sizes
- Selecting the substructure includes a choice of the required locking system (for cabinets) and colour

4. Superstructures and accessories

- Select the superstructures for the workbench
- Customise your workbench with support pillars, appliance rails, lighting, rear panels, shelves and much more



Art. no. **78.875.514**
 Frame: Light grey, RAL 7035.
 Fronts: Light blue, RAL 5012
 (excluding optional beech instead
 of Multiplex worktop)



D 700 mm

Workbenches fitted with drawer cabinets in sizes* **27 × 27 E**

18 × 27 E **27 × 27 E** **36 × 27 E**

 459 × 459 mm



W →	D ↗	H ↑	 kg	Number of drawers (mm)		Art. no. 
1500	700	840	Multiplex	600	-	78.389.XXX
1500	700	890	Multiplex	600	-	78.395.XXX
2000	700	840	Multiplex	360	-	78.394.XXX
2000	700	890	Multiplex	360	-	78.396.XXX
1500	700	840	Multiplex	600	3: 1 × 50 / 1 × 100 / 1 × 150	KEY Lock 78.397.XXX
1500	700	890	Multiplex	600	3: 1 × 50 / 1 × 100 / 1 × 150	KEY Lock 78.875.XXX
2000	700	840	Multiplex	360	3: 1 × 50 / 1 × 100 / 1 × 150	KEY Lock 78.398.XXX
2000	700	890	Multiplex	360	3: 1 × 50 / 1 × 100 / 1 × 150	KEY Lock 78.876.XXX
1500	700	840	Multiplex	1500	4: 2 × 100 / 1 × 200 / 1 × 300	KEY Lock 78.879.XXX
2000	700	840	Multiplex	800	4: 2 × 100 / 1 × 200 / 1 × 300	KEY Lock 78.885.XXX
1500	700	840	Multiplex	1500	5: 1 × 50 / 2 × 100 / 1 × 150 / 1 × 300	KEY Lock 78.888.XXX
2000	700	840	Multiplex	800	5: 1 × 50 / 2 × 100 / 1 × 150 / 1 × 300	KEY Lock 78.889.XXX
1500	700	890	Multiplex	1500	5: 2 × 100 / 1 × 150 / 2 × 200	KEY Lock 78.892.XXX
2000	700	890	Multiplex	800	5: 2 × 100 / 1 × 150 / 2 × 200	KEY Lock 78.893.XXX
1500	700	890	Multiplex	1500	6: 1 × 50 / 2 × 100 / 2 × 150 / 1 × 200	KEY Lock 78.896.XXX
2000	700	890	Multiplex	800	6: 1 × 50 / 2 × 100 / 2 × 150 / 1 × 200	KEY Lock 78.897.XXX

* These workbench examples are fitted with size 27 × 27 E drawer cabinets. Each workbench is also available with drawer cabinets in sizes:

18 × 27 E = 306 × 459 mm (W × D)
 36 × 27 E = 612 × 459 mm (W × D)

Workbenches

With Multiplex top, including pre-assembly and fastening material. Drawer cabinet can be fitted on either the right or the left.

Multiplex top thickness **40 mm**
 Workbench leg height 800/850 mm
 Drawer cabinet width 564 mm
 Drawer cabinet depth 572 mm
 Drawer load capacity 75 kg

For load specifications see p. 130/131

Universal superstructures

Whether workstation system, workbench, compact workbench, team or testing and inspection workstations – the compatible, modular superstructure system is unique due to its flexibility and the variety of ways it can be put together.



i



When ordering a workbench from these two pages with **CODE Lock**, please add the suffix "**C**" or for **RFID** or **AUTO Lock "F"** or "**A**" in addition to the article number from the table (e.g. **78.897.XXX.C**).

» Other locking systems
 see pp. 28–31



S

Art. no. **39.721.010**
Light blue, RAL 5012

D **750/800 mm**

Workbenches fitted with drawer cabinets in sizes* 27 x 36 E

459 x 612 mm



W	D	H		kg	Number of drawers (mm)		Art. no.
1500	750	840	Multiplex	600	-	-	40.961.XXX
1500	750	890	Multiplex	600	-	-	78.900.XXX
1500	750	740-1090**		600			78.265.XXX
1500	800	850	Beech	800	-	-	88.141.XXX
1500	800	900	Beech	800	-	-	78.902.XXX
1500	800	750-1100**		800			78.266.XXX
2000	750	840	Multiplex	360	-	-	40.963.XXX
2000	750	890	Multiplex	360	-	-	78.901.XXX
2000	750	740-1090**		360			78.267.XXX
2000	800	850	Beech	500	-	-	88.143.XXX
2000	800	900	Beech	500	-	-	78.903.XXX
2000	800	750-1100**		500			78.268.XXX
1500	750	840	Multiplex	600	1: 1 x 150	KEY Lock	40.934.XXX
1500	750	890	Multiplex	600	1: 1 x 150	KEY Lock	78.904.XXX
1500	800	850	Beech	800	1: 1 x 150	KEY Lock	59.189.XXX
1500	800	900	Beech	800	1: 1 x 150	KEY Lock	78.906.XXX
2000	750	840	Multiplex	360	1: 1 x 150	KEY Lock	40.936.XXX
2000	750	890	Multiplex	360	1: 1 x 150	KEY Lock	78.905.XXX
2000	800	850	Beech	500	1: 1 x 150	KEY Lock	59.191.XXX
2000	800	900	Beech	500	1: 1 x 150	KEY Lock	78.907.XXX
1500	750	840	Multiplex	600	3: 1 x 50 / 1 x 100 / 1 x 150	KEY Lock	59.005.XXX
1500	750	890	Multiplex	600	3: 1 x 50 / 1 x 100 / 1 x 150	KEY Lock	78.908.XXX
1500	750	740-1090**		600	3: 1 x 50 / 1 x 100 / 1 x 150	KEY Lock	78.269.XXX
1500	800	850	Beech	800	3: 1 x 50 / 1 x 100 / 1 x 150	KEY Lock	59.213.XXX
1500	800	900	Beech	800	3: 1 x 50 / 1 x 100 / 1 x 150	KEY Lock	78.912.XXX
1500	800	750-1100**		800	3: 1 x 50 / 1 x 100 / 1 x 150	KEY Lock	78.270.XXX
2000	750	840	Multiplex	360	3: 1 x 50 / 1 x 100 / 1 x 150	KEY Lock	59.007.XXX
2000	750	890	Multiplex	360	3: 1 x 50 / 1 x 100 / 1 x 150	KEY Lock	78.910.XXX
2000	750	740-1090**		360	3: 1 x 50 / 1 x 100 / 1 x 150	KEY Lock	78.271.XXX
2000	800	850	Beech	500	3: 1 x 50 / 1 x 100 / 1 x 150	KEY Lock	59.215.XXX
2000	800	900	Beech	500	3: 1 x 50 / 1 x 100 / 1 x 150	KEY Lock	78.914.XXX
2000	800	750-1100**		500	3: 1 x 50 / 1 x 100 / 1 x 150	KEY Lock	78.272.XXX

i



When ordering a workbench from these two pages with **CODE Lock**, please add the suffix **"C"** or for **RFID** or **AUTO Lock "F"** or **"A"** in addition to the article number from the table (e.g. **78.897.XXX.C**).

Locking systems see p. 28-31

S

S

S

S



Multiplex top

Thickness 40 mm. Made of steamed beech veneers glued in multiple layers, waterproof, with bevelled edges and sanded, oiled and waxed surface. The top is splash-proof, dirt-repellent and largely impervious to oil and grease.

S



Beechwood top

Thickness 50 mm. Made of glued steamed beech beams, waterproof, with bevelled edges and a sanded, oiled and waxed surface. The top is splash-proof, dirt-repellent and largely impervious to oil and grease.

S

S

S



D 750/800 mm

 Workbenches fitted with drawer cabinets in sizes* **27×36 E**

459×612 mm

W→	D↗	H↑			Number of drawers (mm)		Art. no.
1500	750	840	Multiplex	600	4: 1×50 / 2×100 / 1×200	KEY Lock	59.019.XXX
1500	750	890	Multiplex	600	4: 1×50 / 2×100 / 1×200	KEY Lock	78.916.XXX
1500	800	850	Beech	800	4: 1×50 / 2×100 / 1×200	KEY Lock	59.008.XXX
1500	800	900	Beech	800	4: 1×50 / 2×100 / 1×200	KEY Lock	78.920.XXX
2000	750	840	Multiplex	360	4: 1×50 / 2×100 / 1×200	KEY Lock	59.040.XXX
2000	750	890	Multiplex	360	4: 1×50 / 2×100 / 1×200	KEY Lock	78.918.XXX
2000	800	850	Beech	500	4: 1×50 / 2×100 / 1×200	KEY Lock	59.013.XXX
2000	800	900	Beech	500	4: 1×50 / 2×100 / 1×200	KEY Lock	78.922.XXX
1500	750	840	Multiplex	1500	4: 2×100 / 1×200 / 1×300	KEY Lock	59.039.XXX
1500	800	850	Beech	1500	4: 2×100 / 1×200 / 1×300	KEY Lock	59.009.XXX
2000	750	840	Multiplex	800	4: 2×100 / 1×200 / 1×300	KEY Lock	59.041.XXX
2000	800	850	Beech	1000	4: 2×100 / 1×200 / 1×300	KEY Lock	59.014.XXX
1500	750	840	Multiplex	1500	5: 1×50 / 2×100 / 1×150 / 1×300	KEY Lock	40.970.XXX
1500	800	850	Beech	1500	5: 1×50 / 2×100 / 1×150 / 1×300	KEY Lock	39.719.XXX
2000	750	840	Multiplex	800	5: 1×50 / 2×100 / 1×150 / 1×300	KEY Lock	40.972.XXX
2000	800	850	Beech	1000	5: 1×50 / 2×100 / 1×150 / 1×300	KEY Lock	39.721.XXX
1500	750	890	Multiplex	1500	5: 2×100 / 1×150 / 2×200	KEY Lock	78.924.XXX
1500	800	900	Beech	1500	5: 2×100 / 1×150 / 2×200	KEY Lock	78.928.XXX
2000	750	890	Multiplex	800	5: 2×100 / 1×150 / 2×200	KEY Lock	78.926.XXX
2000	800	900	Beech	1000	5: 2×100 / 1×150 / 2×200	KEY Lock	78.930.XXX
1500	750	890	Multiplex	1500	6: 1×50 / 2×100 / 2×150 / 1×200	KEY Lock	78.932.XXX
1500	800	900	Beech	1500	6: 1×50 / 2×100 / 2×150 / 1×200	KEY Lock	78.936.XXX
2000	750	890	Multiplex	800	6: 1×50 / 2×100 / 2×150 / 1×200	KEY Lock	78.934.XXX
2000	800	900	Beech	1000	6: 1×50 / 2×100 / 2×150 / 1×200	KEY Lock	78.938.XXX
2000	750	840	Multiplex	1500	4 left: 2×100 / 1×200 / 1×300	KEY Lock	59.051.XXX
2000	800	850	Beech	1500	5 right: 1×50 / 2×100 / 1×150 / 1×300	KEY Lock	59.018.XXX
2000	750	890	Multiplex	800	5 left: 2×100 / 1×150 / 2×200	KEY Lock	78.940.XXX
2000	800	900	Beech	1000	6 right: 1×50 / 2×100 / 2×150 / 1×200	KEY Lock	78.942.XXX

18×27 E	27×27 E	36×27 E
18×36 E	27×36 E	36×36 E

* These workbench ordering examples are equipped with drawer cabinets in size 27×36 E. Each workbench is also available with drawer cabinets in sizes:

18×27 E = 306×459 mm (W×D)
 27×27 E = 459×459 mm (W×D)
 36×27 E = 612×459 mm (W×D)
 18×36 E = 306×612 mm (W×D)
 36×36 E = 612×612 mm (W×D)

S Workbenches

With Multiplex or beech top including pre-assembly and fastening material. Drawer cabinet can be fitted on either the right or the left.

Multiplex top thickness	40 mm
Beech top thickness	50 mm
Workbench leg height	800/850 mm
height-adjustable**	700–1050 mm
Drawer cabinet width	564 mm
Drawer cabinet depth	725 mm
Drawer load capacity	75 kg

For load specifications see p. 130/131

S LISTA fast delivery program

These LISTA products in light blue (.010) and light grey (.020) are available ex-works.

.010 Light blue
RAL 5012

.020 Light grey
RAL 7035



Art. no. **69.853.200**
Top-mounted cabinet with aluminium roller shutters anthracite, RAL 7016



Housing

- Sturdy steel structure
- Version without shelf as top-mounted cabinet (direct mounting on countertop) or alternatively with shelf as overhead cabinet, see p. 186/187



Handle

- Integrated handle
- Locking mechanism has no impact on usable depth
- Locking with KEY lock, keyed alike possible on request.

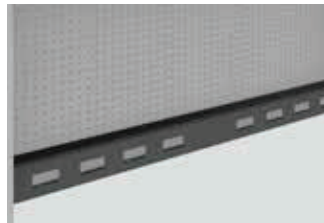

Power conduit

- Optionally integrated power conduit
- Configurable with power modules (see page 145)



Adjustable shelf

- Optional adjustable shelf
- Adjustment increment: 25 mm

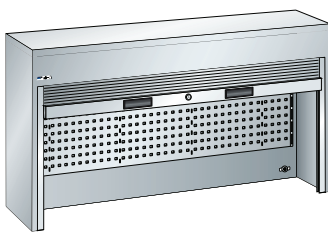

Roller shutter cabinet top-mounted cabinet

Aluminium roller shutters with spring-loaded winding ensures a large usable depth (215 mm) and safe operation (self-locking). The sturdy steel housing and the aluminium roller shutters ensure stable, secure storage. Punch-outs intended for power supply. Mounted directly on countertop.

Perforated rear panel for using perforated wall hooks (see p. 163), with square perforation 10×10 and 38 mm divisions.

Further versions with a height of 800 mm (with shelf) are attached to the support pillar via perforated rear panel (see p. 186/187).

W →	D ↗	H ↑	Model	Art. no.
1500	250	1050	without shelf	69.852.XXX
2000	250	1050	without shelf	69.853.XXX

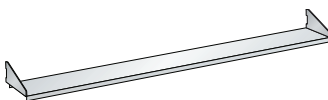

Adjustable shelf

Optional adjustable shelf
Depth 175 mm

W →	D ↗	kg	Art. no.
1500	175	20	69.854.XXX
2000	175	20	69.855.XXX

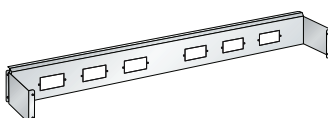

Power conduit set

Integrated cable conduit solution. Designed for installation in roller shutter cabinet. The power conduit can be equipped with the power modules. See page 145

for width mm	for power module mm	Art. no.
1500	6 ×	89.022.XXX
2000	8 ×	89.023.XXX





Workbench legs, stationary, fixed height and height-adjustable

The LISTA workbench leg assembly is a rugged steel construction, welded together with extruded profiles, with holes for fastening the top. The feet can be anchored to the floor through a hole in the base plate. Load capacity 400 kg. Please note the maximum clear width on page 130. Specification: sheet steel. Colour: as per colour chart.

Height mm	For top depth mm	Top thickness mm	Width mm	Depth mm	Art. no. 
800	700	40–50	80	675	43.101.XXX
850	700	40–50	80	675	43.176.XXX
700–1050*	700	40–50	80	675	43.186.XXX
800	750, 800	40–50	80	725	43.111.XXX
850	750, 800	40–50	80	725	43.179.XXX
700–1050*	750, 800	40–50	80	725	43.231.XXX

* Height-adjustable in 25 mm increments.



Levelling plates

For height compensation. For precise alignment, even on uneven floors. Description: PVC. Colour: grey. Dimensions: 90 × 90 mm (W × D)

Thickness mm	Art. no.
1	338.146.000
2	338.147.000
4	304.309.000

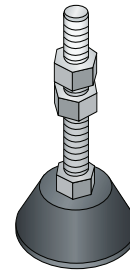

Levelling foot

1 × levelling foot, ø 50 mm, adjustment range 45–90 mm. Including fastening material. Two levelling feet are required per workbench leg assembly. Description: plastic, black.

Art. no.
345.040.000



! Workbench leg assemblies, mobile and height-adjustable

Option to select nylon or rubber coated wheels, depending on the properties of the floor. Width: 80 mm. Depth: 725 mm. Height: 700–1050 mm. Please note the maximum clear width on page 130. Specification: sheet steel. Colour: as per colour chart.

Specification	kg	Wheel Ø mm	Art. no. 
with push handle , without castors	400	-	39.974.XXX
with 2 nylon fixed castors	200	100	39.770.XXX
with 2 rubber fixed castors	200	100	39.965.XXX
with 2 nylon swivel castors, brakes	200	100	39.771.XXX
with 2 rubber swivel castors, brakes	200	100	39.966.XXX
with 2 nylon swivel castors, brakes, push handle	200	100	39.973.XXX
with 2 rubber swivel castors, brakes, push handle	200	100	39.972.XXX



Cross brace

For stabilising the legs on a workbench (e.g. those on a mobile workbench). Including fastening material. Model: sheet steel. Colour: as per colour chart. Scope of delivery: 1 unit



Cross brace for in-line installation

For connecting two workbenches (top with three work legs, 2-part strut). Including fastening material. Model: sheet steel. Colour: as per colour chart.

for top width (2 legs) mm	for leg distance (centre) mm	Strut length mm	Art. no. 
1500	1300	1224	43.233.XXX
2000	1800	1724	43.236.XXX
2500	2300	2224	40.900.XXX

for top width (3 legs) mm	for leg distance (centre) mm	Strut length mm	Art. no. 
2000	900	1648 (2 × 824)	40.833.XXX
2500	1150	2148 (2 × 1074)	43.241.XXX
3000	1400	2648 (2 × 1324)	43.242.XXX



Drawer cabinets

Every workbench is available with drawer cabinets in sizes:

18 × 27 E = 306 × 459 mm (W × D) 18 × 36 E = 306 × 612 mm (W × D)
 27 × 27 E = 459 × 459 mm (W × D) 27 × 36 E = 459 × 612 mm (W × D)
 36 × 27 E = 612 × 459 mm (W × D) 36 × 36 E = 612 × 612 mm (W × D)

18 × 27 E **27 × 27 E** **36 × 27 E**

18 × 36 E **27 × 36 E** **36 × 36 E**

» Drawer cabinets see p. 38



Mobile workbenches

must be fitted with a push handle according to the Product Safety Act. In addition, mobile workbenches must be fitted with a strut for stability.

Storage shelves between workbench leg assemblies, 675 and 725 mm deep

Thickness 20 mm, maximum load capacity 20 kg. Specification: Multiplex top, pre-drilled, including fastening material.

D Depth of storage shelves mm		560	610
For depth of workbench leg assemblies (mm)		675	725
Worktop width mm	Width mm	Art. no.	Art. no.
1500	1420	43.405.000	43.247.000
2000	1920	43.406.000	43.248.000
2500	2420	43.407.000	43.258.000
3000	2920*	43.408.000	43.259.000

* Slotted (two-piece, 2 x 1460 mm), 3 workbench leg assemblies required.

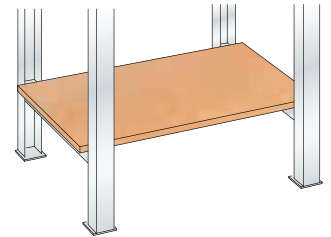

Storage shelves between workbench leg assembly and cabinet, 675 and 725 mm deep

Thickness 20 mm, maximum load capacity 20 kg. Specification: Multiplex top, pre-drilled, including fastening material, without support bracket.

D Depth of storage shelves mm		560	610
For depth of workbench leg assemblies (mm)		675	725
Depth of drawer cabinets (mm)/LISTA Unit		572/27 E	725/36 E
Worktop width mm	Width storage shelves mm	Art. no.	Art. no.
1500	835	43.409.000	43.266.000
2000	1335	43.410.000	43.267.000
2500	1835	43.411.000	43.271.000
3000	2335	43.431.000	43.272.000

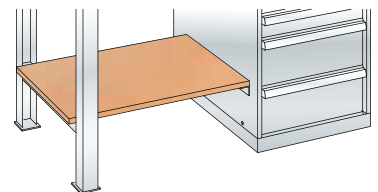

Support bracket for storage shelf on drawer cabinet

Fastening material included. Specification: sheet steel. Colour: light grey, RAL 7035.

For storage shelf depth mm	Workbench depth mm	Art. no.
560	461	43.432.000
610	540	43.273.000

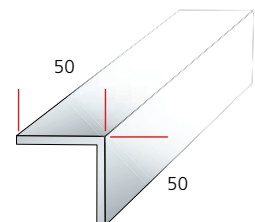

CPU holder

CPU holder attached hanging to the workbench top (minimum top thickness 30 mm). Side holder adjustable for equipment widths of about 100 to 220 mm. Including fastening material. Description: sheet steel. Colour: according to colour chart.

Width mm	Depth mm	Height mm	Art. no.
250	460	510	340.243.XXX

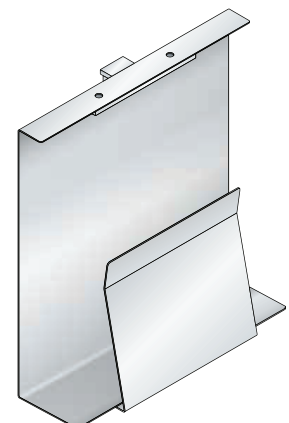

CPU holder pre-assembly

Pre-assembly (pre-drilled holes) excluding fastening material.

Pre-assembly position	Art. no.
left	88.000.000
right	88.001.000



The LISTA workstation system offers the right worktop for every application area, from the universal worktop with linoleum covering to the chrome steel worktop. Another plus point: If the support pillars for the superstructures are fastened behind the worktop, you can make effective use of the full worktop depth with the LISTA system.



Multiplex top

- Made of steamed beech veneers, glued waterproof and with bevelled edges
- Sanded, oiled and waxed surface
- Versatile, splash-proof, dirt-repellent and largely impervious to oil and grease



Beechwood top

- Made of steamed beech beams, glued waterproof and with bevelled edges
- Sanded, oiled and waxed surface
- Extremely resilient, splash-proof, dirt-repellent and largely impervious to oil and grease

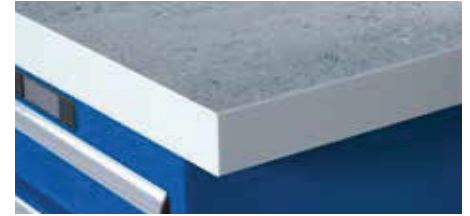

Universal top

- Universal countertop for the workshop
- Linoleum covering, grey marbled, 2 mm, with ABS edges, light grey
- Impact-resistant and slightly dampening
- Limited scratch resistance
- Colour change due to darkness is a natural reaction (disappears in normal light conditions)
- Linoleum is made from natural raw materials



Eterlux top

- For hygienic applications
- HPL coating, 3 mm, with ABS edges 2mm light grey
- Easy-to-clean surface texture
- Highest scratch resistance
- Heat-resistant up to 180°C, briefly up to 280°C
- Resistant to chemicals and solvents, also acids and alkalis to a certain extent
- Limited impact resistance



Nitrile top

- Technical coating of natural rubber
- 4 mm rubber floor covering, with 2 mm black ABS edges
- Medium-hard, slip-resistant and shock-absorbing as well as oil and fuel-resistant
- Can be used at -10°C to +70°C
- Slight clouding or scratches are production-related and correspond to the normal surface condition of the product



Metal coverings (on request)

- For high usage
- Very easy to clean and versatile
- Choice of sendzimir galvanised coating and chrome steel coating



Resin top

- Colour light grey
- Easy-to-clean textured surface with HPL coating, 0.8 mm
- Resistant to common household chemicals, solvents, weak acids and alkalis
- High impact and scratch resistance
- Also available as an ESD model
- With ABS edges, 2 mm, grey



ABS plate

- With hard, slightly grained surface texture, 2 mm
- With ABS edges, 2 mm, black
- High scratch resistance and impact resistance
- Resistant to chemicals, oils and greases



PVC mat, 4 mm, transparent

- Dampening and slip-resistant
- Smooth, soft surface, easy to clean and impact-resistant
- Resistant to chemicals, solvents, weak acids and alkalis with brief exposure
- Do not use in combination with a beech top
- Made to measure (observe general cutting tolerances)
- PVC mat not suitable for beech wood top

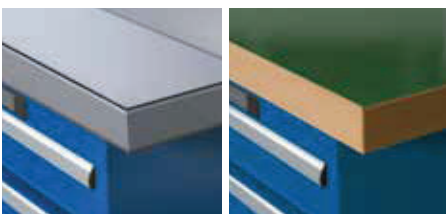

Chrome steel and urphen plates

- Chrome steel plate sealed all round, ideal for pharmaceuticals and laboratories
- Available on request

Art. no.

Size max. 4000 × 1500

39.574.000



Pre-assembly version	for top thickness mm	Number of screws	Art. no.
For move workstation frame C design	30	9 × M6	88.234.000
For move workstation leg, H design	40–50	6 × M10	88.232.000
For move workstation frame, H design	30–50	12 × M8	88.233.000
For workbench leg assembly	40–50	6 × M10	39.327.000
For drawer cabinet	40–50	4 × M10	39.161.000

Threaded inserts, pre-assembled

- For easy attachment of countertops to frame or leg

i Note
All countertops are exclusively pre-assembly and fastening material

Features	Multiplex	Beech	Universal	Eterlux	Nitrile**	Metal coatings	Resin	ABS	PVC mat 4 mm
Impact/shock resistance	●	●	●	○	■	●		●	●
Scratch resistance			●	■	○	■	■	■	
Dampening			○		■				■
Cleaning / Hygiene			○	■		■	■	●	●
Heat resistance (soldering)				●		■	○		
Chemical resistance*			○	●	○	■	●	●	○
Acid resistance*			○	●	○	■	●	●	○
Alkali resistance*			○	●	○	■	●	●	○
Resistance to oil and grease*			●	●	●	■	●	●	●

* incl. visual changes

■ applies above average ● applies ○ applies in part

** Resistant to: good resistance to oil, good or limited resistance to fuel, not recommended for acids, alkalis or acetone. Changes to the surface and slight swelling of the surface caused by using chemicals, oils, soaps, etc. may occur; these are a material property and not a product defect. Excluding threaded inserts (pre-assembled) and fastening material. These must be ordered additionally depending on the sub-structure.

! The recommendations on resistance materials are general indicators and do not take into account secondary factors such as concentration of the agent, temperature, oxidation, etc. The information given is therefore not binding. Depending on the substances, preliminary clarifications are strongly recommended.

! Special and custom solutions on request

Special sizes m ²	Thickness mm	max. size mm	Art. no.
Multiplex	30	2500 × 1250	39.879.000
	40	2500 × 1250	39.344.000
	50	2500 × 1250	41.995.000
Beech	40	3000 × 1200	39.075.000
	50	3000 × 1200	39.020.000
Universal	53	3000 × 1250	39.572.000
Eterlux	52	2750 × 1250	39.573.000
Nitrile*	43	3000 × 1000	39.952.000
	50	3000 × 1000	39.956.000
	23	2740 × 1200	39.881.000
Resin	30	2700 × 2000	88.324.000
	40	3000 × 1000	39.085.000
ABS	40	2000 × 1000	42.519.000

Customer-specific cut-outs and holes

- According to your specifications



* Special size without edges. ABS edge black for nitrile plates 43 and 50 mm. Item no. **39.033.000**

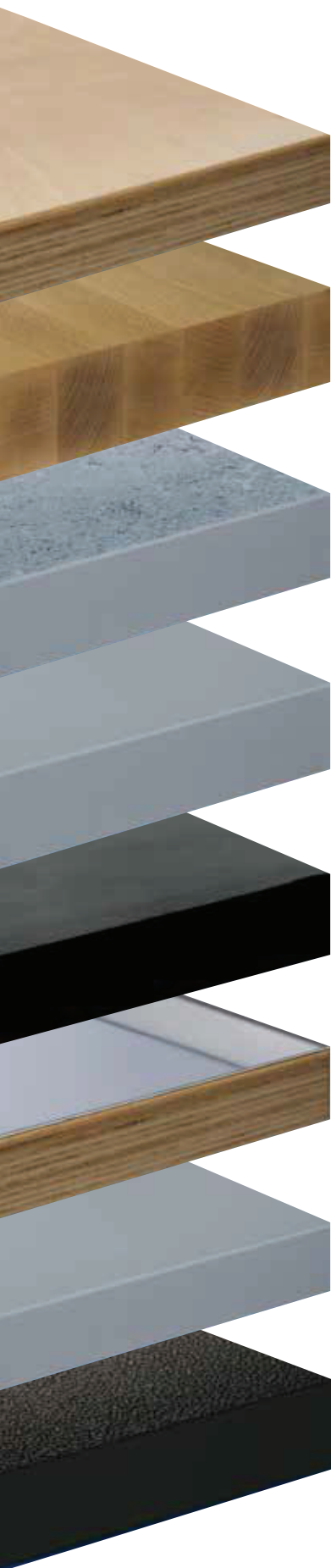

Multiplex

W →	Width mm	1000		
D ↗	Depth mm	700	800	1000

	Thickness mm	Art. no.	Art. no.	Art. no.
Multiplex Standard	30**	-	88.252.000	88.253.000
	40	-	-	-
	50	-	-	-
with rear panel	40	-	-	-
	50	-	-	-
with steel edging protection at the front	40	-	-	-
	50	-	-	-
with chrome steel sheet coating****	40	-	-	-
	50	-	-	-
Beech Standard	40	-	-	-
	50	-	-	-
with rear panel	40	-	-	-
	50	-	-	-
with steel edging protection at the front	40	-	-	-
	50	-	-	-
Universal	53	-	-	-
Eterlux	52	-	-	-
Nitrile	43	-	-	-
	50	-	-	-
Resin	30**	-	88.268.000	88.269.000
	40	-	-	-

* with Multiplex tops 3000 mm = 2 × 1500 mm glued

Metal coverings

Resin

ABS see p. 125



Side panels

The side panels are supplied screwed onto the worktop. Fastening material included. Specification: Multiplex, 150 mm high, thickness 20 mm, oiled.

For top thickness mm	Depth mm	Art. no.
700	720	89.817.000
750	770	89.818.000
800	820	89.819.000

1200				1500				
620	700	800	1000	620	700	750	800	1000
Art. no. 88.254.000	Art. no. 88.255.000	Art. no. 88.256.000	Art. no. -	Art. no. 88.258.000	Art. no. 88.259.000	Art. no. -	Art. no. 88.260.000	Art. no. 88.261.000
-	-	-	-	-	42.850.000	40.025.000	39.035.000	-
-	-	-	-	-	42.854.000	40.045.000	40.185.000	-
-	-	-	-	-	89.616.000	89.624.000	89.632.000	-
-	-	-	-	-	89.620.000	89.628.000	89.636.000	-
-	-	-	-	-	42.874.000	40.035.000	39.767.000	-
-	-	-	-	-	42.878.000	40.055.000	40.195.000	-
-	-	-	-	-	42.898.000	42.906.000	42.914.000	-
-	-	-	-	-	42.902.000	42.910.000	42.918.000	-
-	-	-	-	-	89.684.000	89.692.000	89.696.000	-
-	-	-	-	-	89.688.000	40.001.000	39.015.000	-
-	-	-	-	-	89.716.000	89.724.000	89.732.000	-
-	-	-	-	-	89.720.000	89.728.000	89.736.000	-
-	-	-	-	-	89.740.000	89.748.000	89.752.000	-
-	-	-	-	-	89.744.000	40.013.000	39.329.000	-
-	-	-	-	-	-	39.555.000	39.559.000	-
-	-	-	-	-	-	39.564.000	39.568.000	-
-	-	-	-	-	-	48.975.000	48.983.000	-
-	-	-	-	-	-	48.979.000	48.987.000	-
88.270.000	88.271.000	88.272.000	-	88.274.000	88.275.000	-	88.276.000	88.277.000
-	-	-	-	-	-	39.082.000	39.052.000	-

** Suitable for move C or H design, workstation frame

*** Chrome steel sheet coating 1.5 mm thick, bent down and screwed at the back, open on the sides, multiplex top is visible.

Rear panels

The rear panels, which are supplied unattached, are screwed onto the worktop. Fastening material included. Specification: Multiplex, 150 mm high, thickness 20 mm, oiled.



For top thickness mm	Width mm	Art. no.
1500	1500	89.812.000
2000	2000	89.813.000
2500	2500	89.814.000
3000	3000*	89.815.000

* 2 × 1500 mm, adjoining edges

Shelves with raised sides

Specification: MDF worktop with 8 mm raised beech sides and back. Depth 300 mm, thickness 19 mm. Max. supported load 20 kg per linear metre. Colourless coating on all sides, without brackets (see below). Max. distance between supports 1100 mm.



For top thickness mm	required brackets	Art. no.
1500	2	44.043.000
2000	3	44.044.000
2500	3	44.045.000
3000	4	44.046.000

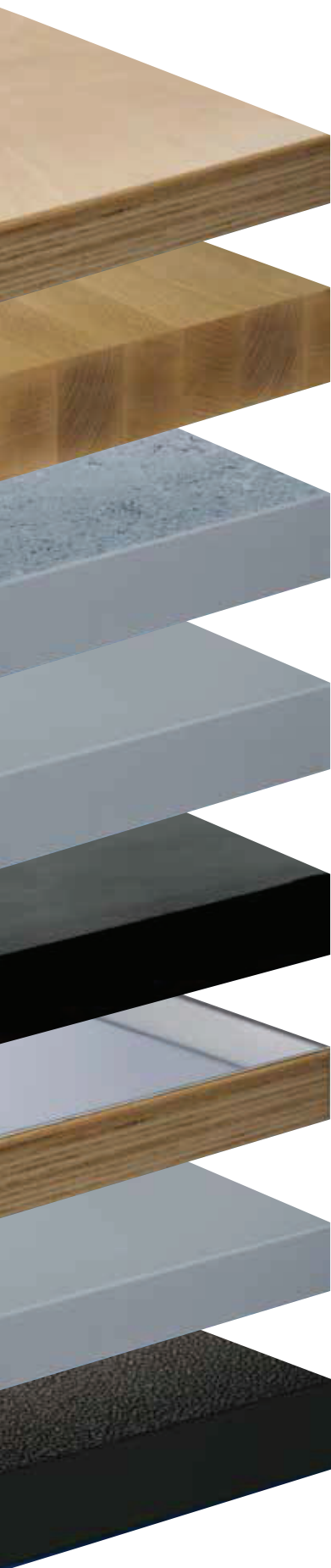

Multiplex

Beech

Universal

Eterlux

Nitrile

Metal coverings

Resin

ABS see p. 125

	Thickness mm	Width mm		
		620	700	750
Multiplex Standard	30**	88.262.000	88.263.000	-
	40	-	42.851.000	40.027.000
	50	-	42.855.000	40.047.000
with rear panel	40	-	89.617.000	89.625.000
	50	-	89.621.000	89.629.000
with steel edging protection at the front	40	-	42.875.000	40.037.000
	50	-	42.879.000	40.057.000
with chrome steel sheet coating****	40	-	42.899.000	42.907.000
	50	-	42.903.000	42.911.000
Beech Standard	40	-	89.685.000	89.693.000
	50	-	89.689.000	40.003.000
with rear panel	40	-	89.717.000	89.725.000
	50	-	89.721.000	89.729.000
with steel edging protection at the front	40	-	89.741.000	89.749.000
	50	-	89.745.000	40.015.000
Universal	53	-	-	39.556.000
Eterlux	52	-	-	39.565.000
Nitrile	43	-	-	48.976.000
	50	-	-	48.980.000
Resin	30**	88.278.000	88.279.000	-
	40	-	-	39.083.000

* with Multiplex tops 3000 mm = 2 x 1500 mm glued



Brackets, height-adjustable

Enable the shelves with raised sides to be adjusted to four different heights. Adjustment height relative to worktop 230, 270, 310 and 350 mm. They are fixed in place through the workbench top (pre-assembly required). Including fastening material. Specification: made from steel box section, including fastening material for each unit. Colour: light grey, RAL 7035.

Description	Depth mm	Art. no.
Brackets , height-adjustable	280	44.047.000
Pre-assembly per bracket (please specify position)	-	39.208.000

2000		2500			3000*		
800	1000	700	750	800	700	750	800
Art. no. 88.264.000	Art. no. 88.265.000	Art. no. -	Art. no. -	Art. no. -	Art. no. -	Art. no. -	Art. no. -
39.037.000	-	42.852.000	40.028.000	39.039.000	42.853.000	42.858.000	42.860.000
40.187.000	-	42.856.000	40.048.000	40.188.000	42.857.000	42.859.000	42.861.000
89.633.000	-	89.618.000	89.626.000	89.634.000	89.619.000	89.627.000	89.635.000
89.637.000	-	89.622.000	89.630.000	89.638.000	89.623.000	89.631.000	89.639.000
39.768.000	-	42.876.000	40.038.000	39.769.000	42.877.000	42.882.000	42.884.000
40.197.000	-	42.880.000	42.058.000	40.198.000	42.881.000	42.883.000	42.885.000
42.915.000	-	42.900.000	42.908.000	42.916.000	42.901.000	42.909.000	42.917.000
42.919.000	-	42.904.000	42.912.000	42.920.000	42.905.000	42.913.000	42.921.000
89.697.000	-	89.686.000	89.694.000	89.698.000	89.687.000	89.695.000	89.699.000
39.017.000	-	89.690.000	40.004.000	39.018.000	89.691.000	40.005.000	39.019.000
89.733.000	-	89.718.000	89.726.000	89.734.000	89.719.000	89.727.000	89.735.000
89.737.000	-	89.722.000	89.730.000	89.738.000	89.723.000	89.731.000	89.739.000
89.753.000	-	89.742.000	89.750.000	89.754.000	89.743.000	89.751.000	89.755.000
39.331.000	-	89.746.000	40.016.000	39.332.000	89.747.000	40.017.000	39.333.000
39.560.000	-	-	39.557.000	39.561.000	-	39.558.000	39.562.000
39.569.000	-	-	39.566.000	39.570.000	-	-	-
48.984.000	-	-	48.977.000	48.985.000	-	48.978.000	48.986.000
48.988.000	-	-	48.981.000	48.989.000	-	48.982.000	48.990.000
88.280.000	88.281.000	-	-	-	-	-	-
39.076.000	-	-	39.134.000	39.135.000	-	39.084.000	39.086.000

** Suitable for move C or H design, workstation frame

*** Chrome steel sheet coating 1.5 mm thick, bent down and screwed at the back, open on the sides, multiplex top is visible.



Stop buffer

Stop buffer prevents the mobile drawer cabinet from rolling too deep under the table. The stop buffer is attached to the underside of the countertop (thickness > 40 mm) with wood screws. Designed for mobile drawer cabinet H: 890 in combination with stationary drawer cabinet H: 850 mm and levelling feet +50 mm

Width mm	Height mm	Art. no.
620	155	69.965.XXX



Support crossbar

By stabilising the countertop using a support crossbar, large spans of up to 2500 mm can be achieved without the use of a third workbench leg assembly. This support crossbar can also be retrofitted to the workbench leg assemblies.

for top width mm	for top depth mm	Load capacity kg	Art. no.
2000	800	500	89.155.XXX
2500	800	500	89.156.XXX





Dimensions

Distances between supports with 2 or 3 workbench leg assemblies, with or without storage shelf

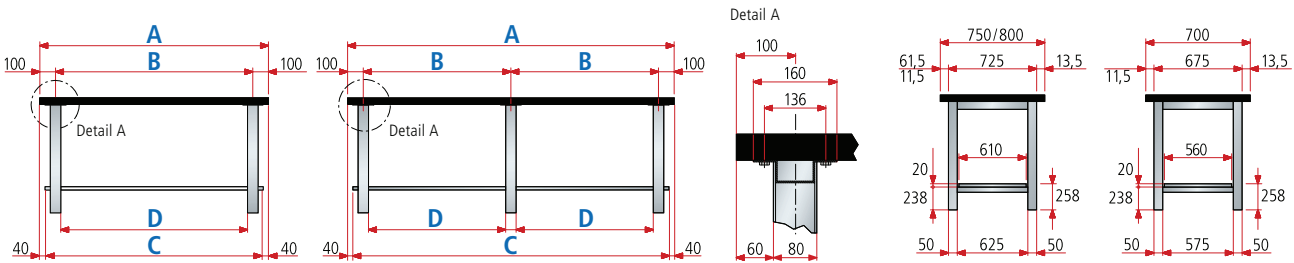

Worktop width mm	Number of leg assemblies	Multiplex		Beech		Universal	Eterlux	Nitrile		Resin	ABS	Width between supports mm	Storage shelf mm	Clear width mm	
		40 mm	50 mm	40 mm	50 mm	53 mm	52 mm	43 mm	50 mm	40 mm	40 mm				
W →		A											B	C	D
1500	2	●	●	●	●	●	●	●	●	●	●	1300	1420	1220	
2000	2	●	●	●	●	●**	●**	●	●	●**	●**	1800	1920	1720	
2000	3	●	●	●	●	●	●	●	●	●	●	900	1920	820	
2500	2	●**	●	●**	●	●**	●**	●**	●	●**	●**	2300	2420	2220	
2500	3	●	●	●	●	●	●	●	●	●	●	1150	2420	1070	
3000*	3	●	●	●	●	●	●	●	●	●	●	1400	2 × 1460	1320	

Distances between supports with workbench leg assembly and drawer cabinet 27 × 27 E or 27 × 36 E, with or without storage shelf

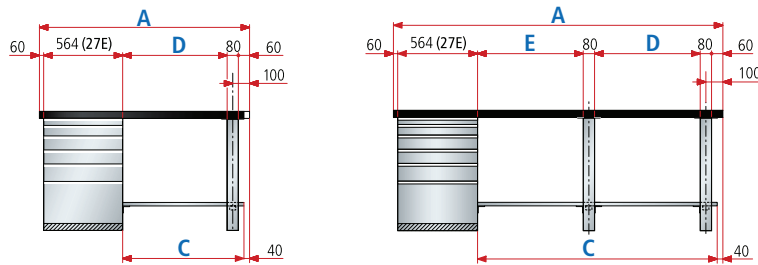

18 × 27 E	27 × 27 E	36 × 27 E
18 × 36 E	27 × 36 E	36 × 36 E

Note
 Workbenches are also available with drawer cabinets in sizes:
 18 × 27 E = 306 × 459 mm (W × D)
 27 × 27 E = 459 × 459 mm (W × D)
 36 × 27 E = 612 × 459 mm (W × D)
 18 × 36 E = 306 × 612 mm (W × D)
 27 × 36 E = 459 × 612 mm (W × D)
 36 × 36 E = 612 × 612 mm (W × D)

Worktop width mm	Number of leg assemblies	Multiplex		Beech		Universal	Eterlux	Nitrile		Resin	ABS	Storage shelf mm	Clear width mm	Clear width mm	
		40 mm	50 mm	40 mm	50 mm	53 mm	52 mm	43 mm	50 mm	40 mm	40 mm				
W →		A											C	D	E
1500	1	●	●	●	●	●	●	●	●	●	●	835	736	-	
2000	1	●	●	●	●	●	●	●	●	●	●	1335	1236	-	
2500	1	●	●	●	●	●	●	●	●	●	●	1835	1736	-	
2500	2	-	-	-	-	-	-	-	-	●**	●**	1835	1070	586	
3000*	2	●	●	●	●	●	●	●	●	●	●	2335	1320	836	

* Multiplex 2 × 1500 mm glued.

** When using the support crossbar, see page 129

● possible

- not possible



Loads

Workbench tops

Max surface loads of the tops. These specifications apply with evenly distributed loads and static applications.

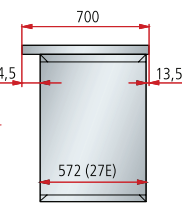
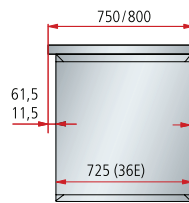
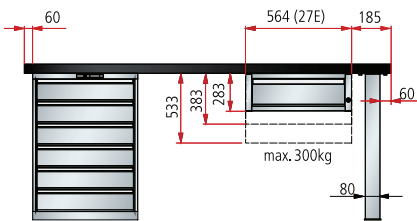

» Desk chairs
see p. 164–167

» Superstructures and
accessories see p. 132

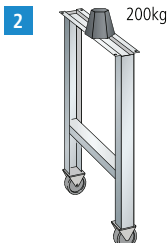
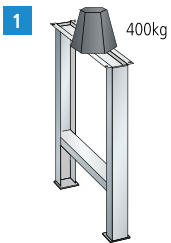

1 The maximum load is 400 kg for the fixed workbench leg assembly and 200 kg for the workbench leg assembly with castors with evenly distributed loads and static applications.

2 For this version, the load specifications (see tables below) must be halved in each case.

Loads with workbench legs or a combination of workbench legs and drawer cabinet



	Top thickness mm	Worktop width mm			Worktop width mm			Worktop width mm			Worktop width mm	
		1500	2000	2500	2000	2500	3000	1500	2000	2500	2500	3000
Multiplex	40	600 kg	360 kg	500 kg*	1200 kg	1050 kg	650 kg	1500 kg	800 kg	360 kg	3000 kg	1600 kg
Multiplex	50	800 kg	500 kg	400 kg	1200 kg	1200 kg	1200 kg	1500 kg	1000 kg	500 kg	3000 kg	2000 kg
Beech	40	600 kg	360 kg	500 kg*	1200 kg	1050 kg	650 kg	1500 kg	800 kg	360 kg	3000 kg	1600 kg
Beech	50	800 kg	500 kg	400 kg	1200 kg	1200 kg	1200 kg	1500 kg	1000 kg	500 kg	3000 kg	2000 kg
Universal	53	700 kg	350 kg	500 kg*	900 kg	700 kg	450 kg	1100 kg	700 kg	350 kg	3000 kg	1400 kg
Eterlux	52	700 kg	350 kg	500 kg*	900 kg	700 kg	450 kg	1100 kg	700 kg	350 kg	3000 kg	1400 kg
Nitrile	43	500 kg	320 kg	500 kg*	800 kg	680 kg	360 kg	700 kg	310 kg	320 kg	1800 kg	1100 kg
Nitrile	50	800 kg	450 kg	300 kg	1200 kg	1200 kg	720 kg	1300 kg	600 kg	300 kg	3000 kg	1400 kg
Resin	40	350 kg	500 kg*	500 kg*	650 kg	400 kg	300 kg	650 kg	350 kg	500 kg*	1100 kg	700 kg
ABS	40	350 kg	500 kg*	500 kg*	650 kg	400 kg	300 kg	650 kg	350 kg	500 kg*	1100 kg	700 kg

* When using a support beam, see p. 129

Overview of universal superstructures

With our universal superstructures, you can design each workstation ergonomically, neatly and individually. The consistent and form-fitting design ensures an attractive appearance and enables virtually invisible cable routing. All superstructures are easy to install and also available as an ESD model.



- Cantilever, single, double sided**
- Integrated and interlocking design for almost invisible cabling.

see page 139



- Rear panels**
- Perforated or smooth
 - For attaching tool holders
 - Smooth rear panels can also be mounted on the back for a complete room partition

see page 140/141

- Support pillars**
- Flexibly mountable
 - Vertically adjustable in increments of 50 mm
 - Continuously adjustable horizontally for flexible attachment to any substructure

see page 138/139

- Rear power panel**
- For accommodating power modules and elements
 - Fully integrated into the rear panel
 - Simple assembly and dismantling

see page 144

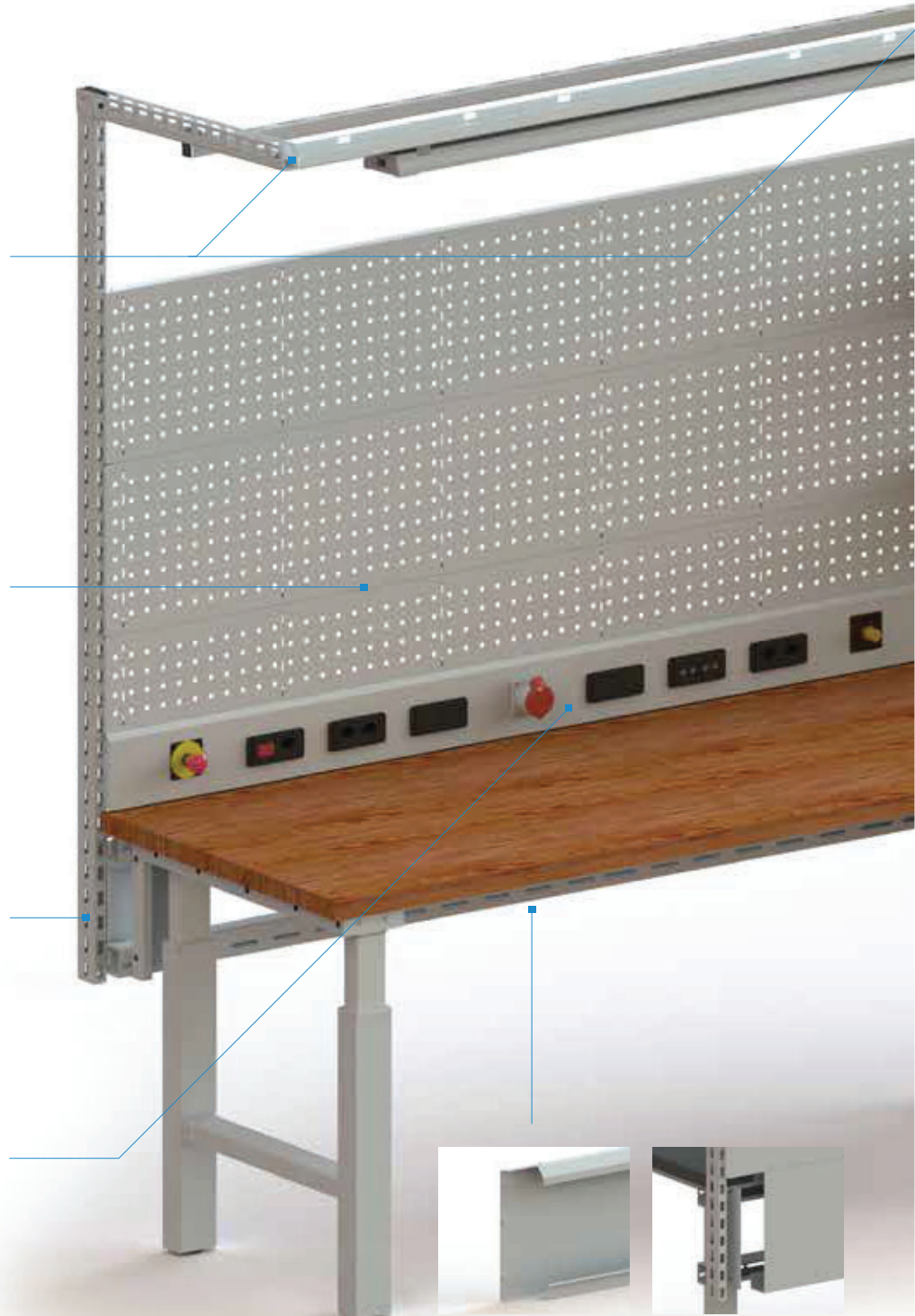

Cable trough (visualisation: sectional view)

- Fastening to the rear side of support pillars
- Optimum cable routing and protection
- Suitable for linked solutions

see page 144

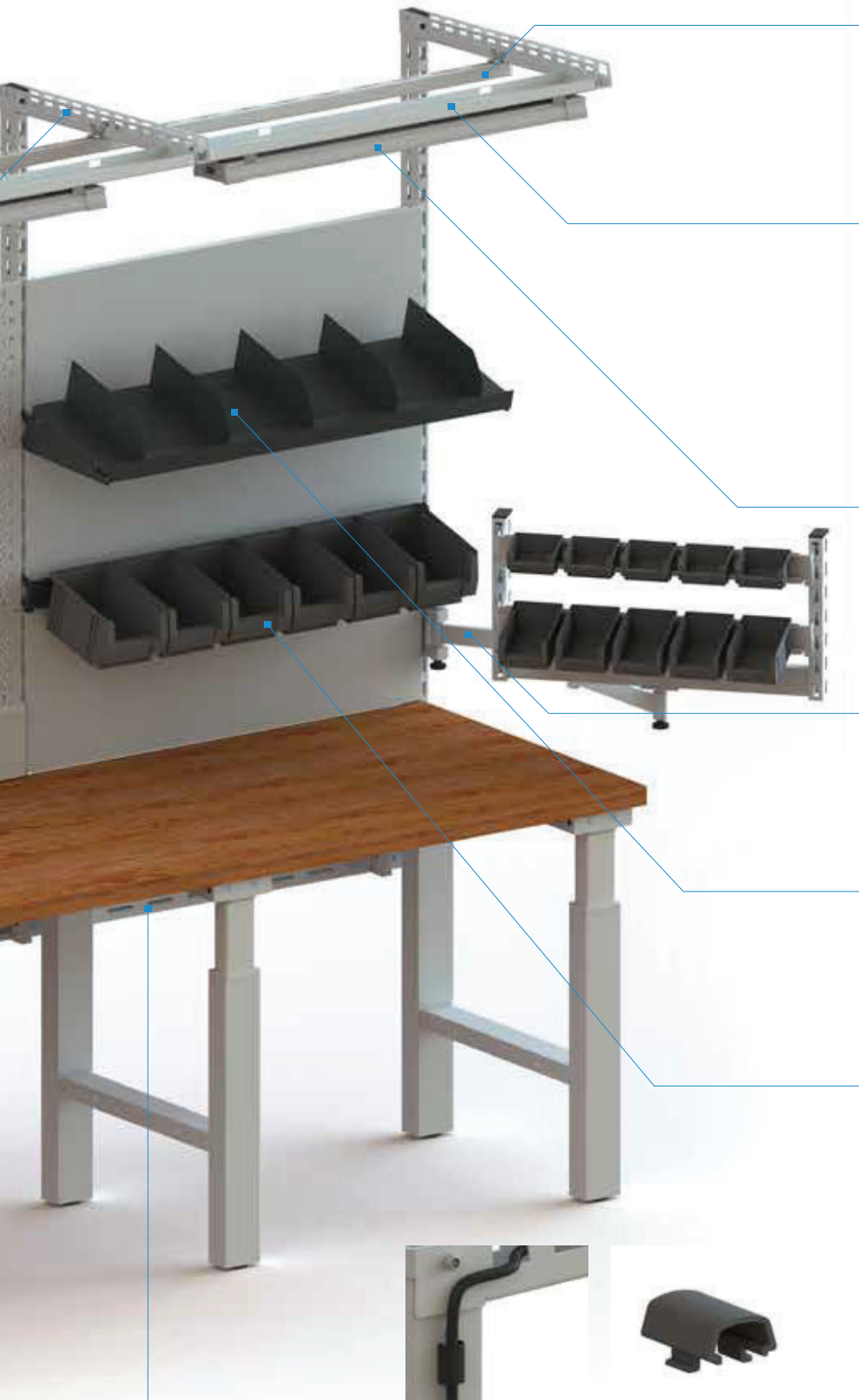

Equipment rail

- For use with carriages
- Fast and easy assembly
- Linking possible via multiple workstations

see page 139



Integrated lighting carrier

- For accommodating lighting and cabling.
- Interlocking design for almost invisible cabling

see page 139

Lighting

- Wide selection of different LED lights

see page 146

Swivel arm

- For mounting on support pillar
- One or two arms
- For holding peripheral devices and accessories

see page 140

Adjustable shelf

- Load capacity up to 50 kg
- Can be attached horizontally or tilted at an angle of up to 15 degrees
- Can be attached largely without tools

see page 140/141

Container strips

- For holding storage containers
- Can be attached horizontally or at an angle of 15 degrees
- Can be attached largely without tools

see page 140/141



Guide rail

- For fastening and horizontal positioning of support pillars

see page 138

Cable routing clip

- Enables clean cable routing, easy installation and removal
- Suitable for support pillars and perforated rear panels

see page 144



ESD

- ESD protected version available as an option

see page 24–27

Superstructures on the workbench substructure for move H design or workbenches

Support pillars on the workbench substructure



load capacity of up to 150 kg

- 1 Guide rail pair
- 2 Support pillar

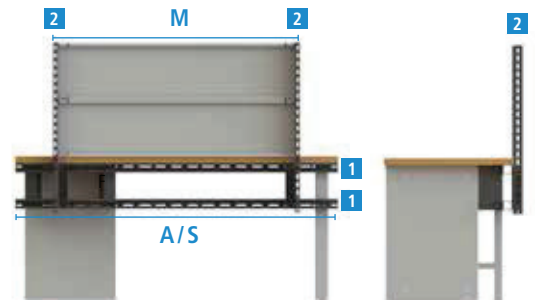

Module width of superstructures mm

Top width mm	Support rail pair width mm	Module width of superstructures mm							Number of support pillars with standard
		665	750	1000	1330	1500	2000	Standard	
A	S	M							2
1000	1000	●	●	●	-	-	-	1×1000	2
1500	1500	●	●	●	●	●	-	1×1500	2
2000	2000	●	●	●	●	●	●	1×2000	2
2500	2500	●	●	●	●	●	●	1×1500, 1×1000	3
3000	3000	●	●	●	●	●	●	2×1500	3

● possible - not possible

Use of TWIN link adapters for drawer cabinet depth 27 E

Different adapter plates (TWIN links) are required to enable different configuration options between countertop depths and drawers with cabinet depths of 27 E. Generally, a TWIN link does not need to be used when **using a drawer cabinet with a depth of 36 E**. The use of the cover profile may be necessary when using a 700 or 750 mm deep countertop, see p. 138.



Countertop Depth mm	Cabinet / Cabinet				Cabinet / Workbench leg assembly				Workbench leg assembly / Workbench leg assembly			
	Cabinet Depth E	Cabinet Depth E	TWIN link	Cover profile**	Cabinet Depth E	Leg Depth mm	TWIN link*	Cover profile**	Leg Depth mm	Leg Depth mm	TWIN link*	Cover profile**
700	27	27	A	-	27	675	B	yes	675	675	-	yes
750	27	27	B	-	27	675	B	-	675	675	-	-
	36	36	-	yes	36	725	-	yes	675	675	-	-
800	27	27	C	-	27	725	C	-	725	725	-	-
	36	36	-	-	36	725	-	-	725	725	-	-

* TWIN link is not required for workbench leg assembly

** + 50 mm

Configuration of support pillars and rear panels

Rear panels optional
(as room divider or for rear use)

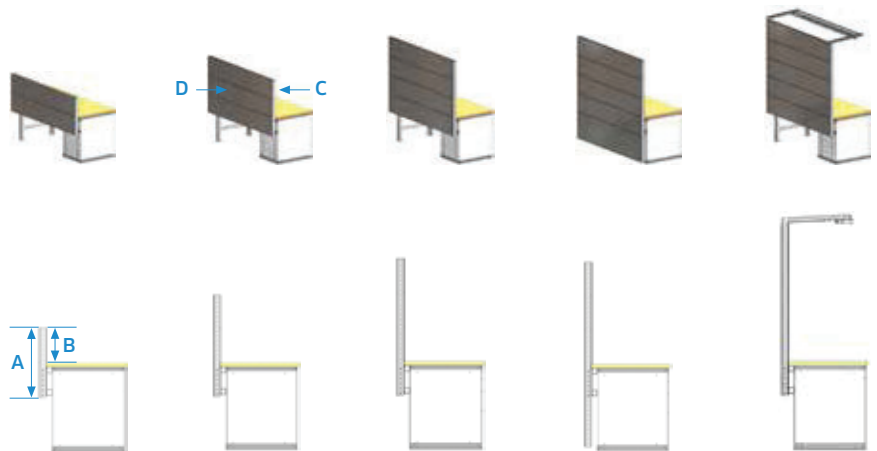

A	Support pillar height		700	1050	1400	1900	1800
B	Usable height		350	700	1050	1050	1400
C	Number of rear panels at front	350*	1	2	3	3	3
		350**	2	3	4	4	5
D	Number of rear panels at rear	500	-	-	-	1	-

* Alternative variant: Power conduit cover plate 150 mm (see p. 144) with a rear panel 200 mm (see p. 140/141)

** Alternative variant: Cable tray (see p. 144)



Superstructures on workbench substructure for workstation frame, C design



Module widths of workstation frame, C design

Support pillars generally on the substructure, load capacity up to 150 kg

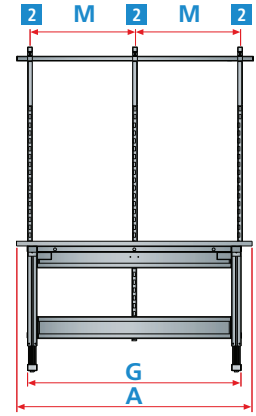
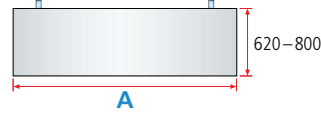

Worktop width mm	Frame width mm	Module width of superstructures mm						Max. installation width for superstructures	Standard	Number of support pillars with standard
		665	750	1000	1330	1500	2000			
A	G					M				2
1200	1030	●	●	●	-	-	-	1000	1 × 665	2
1500	1360	●	●	●	●	-	-	1330	1 × 1330	2
2000	1780	●	●	●	●	●	-	1665	1 × 665, 1 × 1000	3

● possible - not possible

Superstructures on workbench tops for H design, workbenches, compact and system workbenches



Superstructures with support pillars on worktop¹

load capacity up to 100 kg

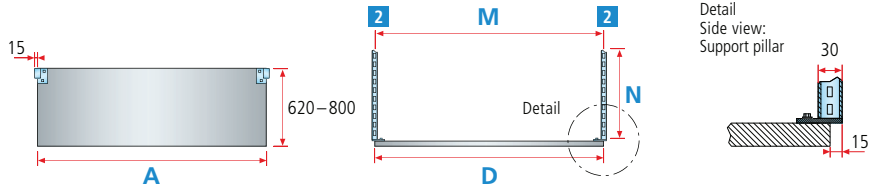

Worktop width mm	Module width of superstructures mm						Standard	Number of support pillars with standard
	665	750	1000	1330	1500	2000		
A				M				2
1000*	●	●	●	-	-	-	1 × 1000	2
1250**	●	●	●	-	-	-	1 × 1000	2
1500	●	●	●	●	●	-	1 × 1500	2
2000	●	●	●	●	●	●	1 × 2000	2
2500	●	●	●	●	●	●	1 × 1500, 1 × 1000	3
3000	●	●	●	●	●	●	2 × 1500	3

* Worktop width available only for compact workbenches.

** Worktop width available only for system workbenches.

¹ Only suitable for mounting on workbench tops made from beechwood and Multiplex.

● possible - not possible



Nom. width mm	350	700	1050	1400***
Pillar height mm	350	700	1050	1400

	N			
Workbench	●	●	●	●
Compact workbench	●	●	●	●
System workbench	●	●	●	●

*** must be stabilised by supporting bracket.

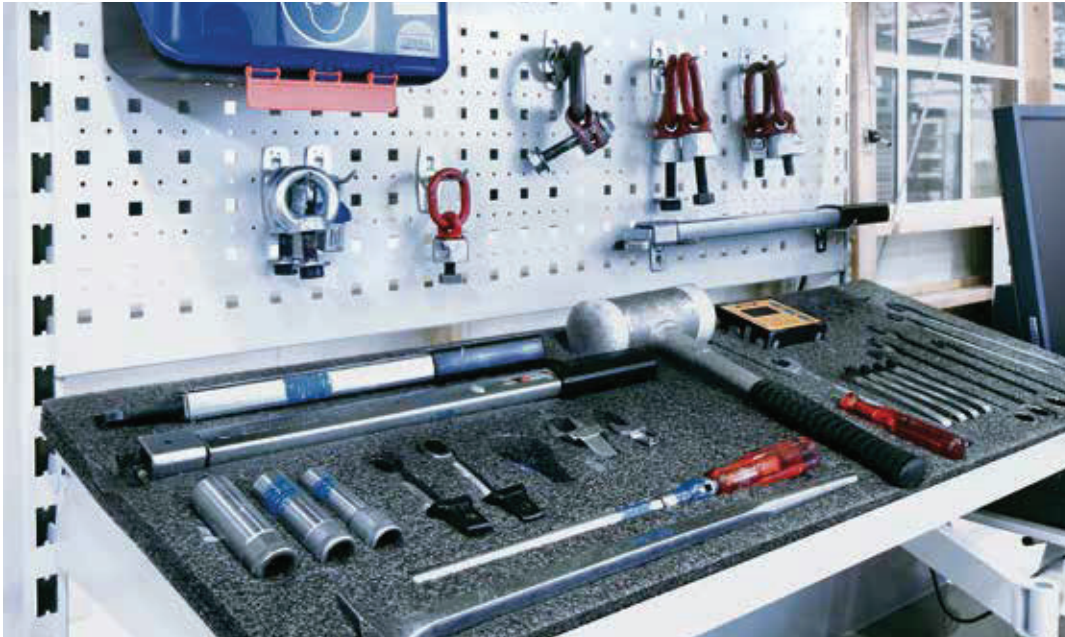

i The preconfigured workstations only consist of the superstructure. Simple expansion and rearrangement to suit specific requirements. The substructures (legs or frame) must be ordered separately.

Lighting must be ordered separately, see page 146



Universal superstructures for workbench leg assemblies

Equipment	for top width mm	Module width mm	Type	H mm	Art. no.
2 support pillars for mounting on workbench top	1500	1500	-	700*	89.070.XXX
2 perforated rear panels	2000	2000	-	700*	89.071.XXX



2 support pillars for mounting on workbench top including left and right support brackets	1500	1500	DE/PE	1460*	89.072.XXX
2 brackets for support pillars	2000	2000	DE/PE	1460*	89.073.XXX
2 brackets for support pillars	1500	1500	CH**	1460*	89.062.XXX
1 equipment rail including 2 suspension sets	2000	2000	CH**	1460*	89.063.XXX
1 carriage	2000	2000	CH**	1460*	89.063.XXX
1 perforated rear panel	1500	1500	F	1460*	89.064.XXX
1 adjustable shelf, plain, depth 350 mm	2000	2000	F	1460*	89.065.XXX
1 power rear panel preconfigured, mounting on support pillar, with 1 switch and 5 sockets 230 V, including connecting cable	1500	1500	GB	1460*	89.066.XXX
	2000	2000	GB	1460*	89.067.XXX

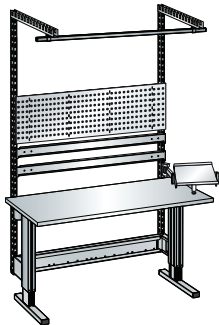

Universal superstructures for workstation frame, C design

2 support pillars	1500	1330	-	1210*	89.074.XXX
2 brackets for support pillars					
1 equipment rail including 2 suspension sets					
1 carriage					
1 perforated rear panel					
2 container strips					
1 swivel arm fixing device					
1 double joint swivel arm					
1 swivelling shelf					

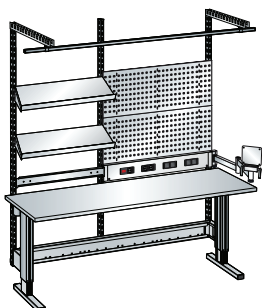

3 support pillars	2000	1000/665	DE/PE	1210*	89.075.XXX
2 brackets for support pillars	2000	1000/665	CH***	1210*	89.076.XXX
1 equipment rail including 2 suspension sets	2000	1000/665	F	1210*	89.077.XXX
1 carriage	2000	1000/665	GB	1210*	89.078.XXX
2 perforated rear panels					
1 container strip					
2 adjustable shelves, plain, depth 350 mm					
1 swivel arm fixing device					
1 double joint swivel arm					
1 TFT monitor mount					
1 rear power panel preconfigured, mounting on support pillar, with 1 switch and 3 sockets 230 V, including connecting cable					



* Height from upper edge of table top mm

** Type CH: 1 switch with 1 thermal fuse and 4 socket outlets 230 V

*** Type CH: 1 switch with 1 thermal fuse and 2 socket outlets 230 V

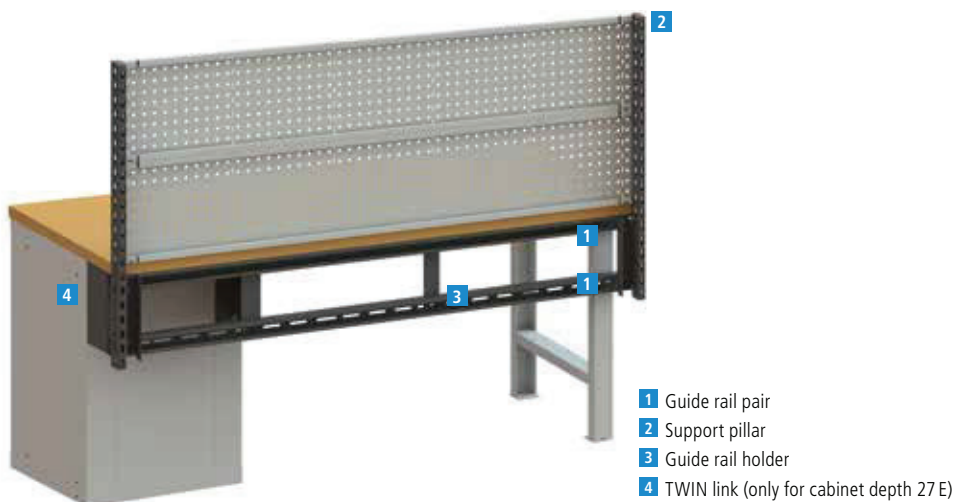

- 1 Guide rail pair
- 2 Support pillar
- 3 Guide rail holder
- 4 TWIN link (only for cabinet depth 27 E)

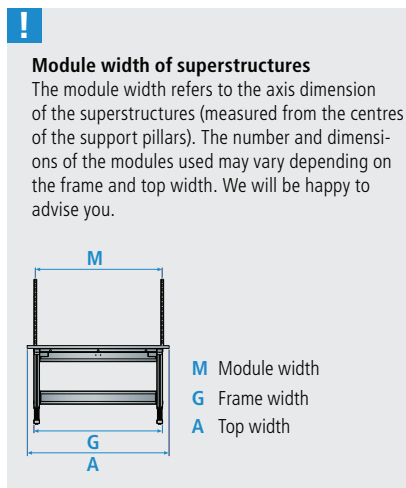

Guide rail pair for fitting to the workbench substructure*

The guide rail pair is available in 5 widths and is designed for the H leg, workbench leg assembly and for the drawer cabinet. Incl. fastening material. Model: Sheet steel, colour as per colour chart.



W → mm	Art. no.
1000	89.140.XXX
1500	89.141.XXX
2000	89.142.XXX
2500	89.143.XXX
3000	89.144.XXX

* Se si utilizza l'armadio a cassettei T: 27 E è necessario un adattatore TWIN-Link.

Support pillar for mounting on workbench substructure

Scope of delivery: 1 unit

To guide rail pair for
Workbench leg assembly
move workstation leg, H design
move workstation frame, H design

The support pillars are available in 5 heights. Capacity 150 kg. A guide rail pair is required for fitting. Incl. pillar bracket and fastening material. Model: Steel profile, perforated on four sides in increments of 50 mm for attaching the superstructure components with limited use of screws. For double workstations, the same support pillars are used for both sides. Colour: as per colour chart.



H ↑ mm	Usable height mm	Art. no.
700	350	89.225.XXX
1050	700	89.226.XXX
1400	1050	89.227.XXX
1800	1400	89.228.XXX
1900	1050	89.229.XXX

Guide rail holder

To further stabilize the guide rail pair, this rail holder can be used, which is attached to the underside of the countertop. Model: Sheet steel, colour: as per colour chart.



W → × D ↗ × H ↑ mm	Art. no.
60 × 272 × 272	89.130.XXX

TWIN link adapter

Different adapter plates (TWIN links) are necessary to enable different configuration options between countertop depths and drawer cabinet depths of 27 E. The required TWIN link size can be found in the matrix on page 134. Model: sheet steel. Colour: as per colour chart.



Type	D ↗ mm	Art. no.
A	52.5	89.149.XXX
B	102.5	89.147.XXX
C	152.5	89.148.XXX

move workstation frame, C design

The support pillars are available in two different heights and are mounted onto the cross-bars of the frame using the fastening material provided. Capacity 150 kg. Model: Steel profile, perforated on four sides in increments of 50 mm for attaching the superstructure components with limited use of screws. For double workstations, the same support pillars are used for both sides. Colour: as per colour chart.

H ↑ mm	Usable height mm	Art. no.
1000	350	65.128.XXX
1700	1050 / 1150	65.129.XXX

Cover profiles for workbench

Matching cover profiles fill the gap between the countertop and support pillar for workbenches (planning information, see page 134), including fastening material. Description: sheet steel. Colour: according to colour chart.



W → mm	D ↗ mm	for top thickness mm	Art. no.
1500	50	40/50	89.330.XXX
2000	50	40/50	89.333.XXX
2500	50	40/50	89.336.XXX

Support pillars for mounting onto countertops

The support pillars are available in four different heights and must be screwed directly onto the top surface on site using the fastening material provided. Capacity 100 kg. Model: Steel profile, perforated on four sides in increments of 50 mm for attaching the superstructure components with minimum use of screws. Colour: as per colour chart. Only suitable for mounting on countertops made from beechwood and multiplex. Plate thickness min. 40 mm. Mounting options on other countertops on request.

Pillar height mm	Left	Centre	Right
350	89.423.XXX	89.420.XXX	89.424.XXX
500	343.328.XXX	344.108.XXX	343.327.XXX
700	89.425.XXX	89.421.XXX	89.426.XXX
1050	89.952.XXX	89.954.XXX	89.953.XXX
1400*	89.427.XXX	89.422.XXX	89.428.XXX

* When loaded to capacity, a support bracket is mandatory (see below).



Support bracket

To provide additional stability for the support pillars on the countertop. Mandatory from pillar heights of 1400 mm. Model: Sheet steel. Colour: as per colour chart.

	Art. no.
Left	89.433.XXX
Right	89.434.XXX



Support pillars for wall mounting

For mounting rear panels, adjustable shelves and container strips directly to the wall. Fastening material included. Specification: Steel U-profile, increments of 50 mm, sinkhole for wall mounting every 200 mm on concrete wall (nylon wall plugs No. 8 and countersunk screw 5 x 70). Colour: as per colour chart. Swivel shelves cannot be attached to wall-mounted rails.

H mm	Width mm	Depth mm	Art. no.
350	30	40	89.435.XXX
700	30	40	89.436.XXX
1050	30	40	89.437.XXX

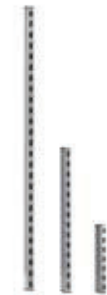

Cantilever

The cantilever is fastened to the support pillar and serves to hold the equipment rail and the lighting carrier. In addition, the cantilever ensures clean and almost invisible cable routing as a cable conduit. The double-sided version is used for double workstations. Incl. fastening material. Load capacity 15 kg. Model: sheet steel. Colour: as per colour chart.

	Art. no.
Simple	89.232.XXX
Double-sided	89.233.XXX



Equipment rail

For supporting the carriage. The equipment rail is attached directly to the cantilever and can be individually adjusted in depth. Load capacity 15 kg. (Delivery excluding carriage: **89.452.000**). Sheet steel version. Colour: as per colour chart.

Width mm	Art. no.
665	89.240.XXX
750	89.241.XXX
1000	89.242.XXX
1330	89.244.XXX
1500	89.245.XXX
2000	89.246.XXX
2500	89.247.XXX

Lighting support

The lighting carrier is mounted directly on the cantilever without tools and can be individually adjusted in depth. It serves to hold LISTA lighting (see page 146) and ensures clean and almost invisible cable routing. Module widths 1665 mm (**89.001.XXX**) and 1750 mm (**89.000.XXX**) are also available for special configuration purposes. Model: Sheet steel, colour: as per colour chart.

Module width mm	Art. no.
665	89.234.XXX
750	89.235.XXX
1000	89.236.XXX
1330	89.237.XXX
1500	89.238.XXX
2000	89.239.XXX



Perforated rear plain or panels

The support pillars can be vertically fitted with rear panels, either partially or up to their full height. All rear panels can be attached to the support pillars without screws. Rear panels perforated with square holes 10 × 10 mm, 38 mm division and slots 380 mm apart for accommodating storage shelves and can holders (see p. 141). Specification: sheet steel. Colour: as per colour chart.

Container strips

To hold size 2, 3 and 4 storage containers; can be attached to the support pillars without screws. Max. load capacity 15 kg. Specification: sheet steel. Colour: as per colour chart.

Adjustable shelves, plain or slotted

The adjustable shelves are fitted with a stop bar on one of their longitudinal sides. The adjustable shelves can be attached with the stop bar on either the front or the rear. For adjustable shelves, slotted: slots 15 mm apart for partitioning with dividers. Using two brackets, the adjustable shelves are attached to the support pillars without screws, either horizontally or with an inclination angle of 15°. Load capacity 50 kg. Normal level 25 mm + 17 mm stop bar. Including two brackets each. Specification: sheet steel. Colour: as per colour chart.

Swivel arm attachments

For accommodating the swivel arm elements directly on the table frame (individual workstation) or on the support pillar. Table frame holder galvanised. Specification: steel. Colour: light grey, RAL 7035.

Fixing to	Width mm	Height mm	Depth mm	kg	Art. no.
Table frame	30	280	30	25	65.244.000
Support pillar	30	105	123	25	65.346.000

Swivel arm

Double-jointed swivel arms with 1 axis and 1 swivel arm add-on. The swivel arm add-ons are fitted with internal slide bearings. The swivel radius is 300 mm. Specification: steel. Colour: light grey, RAL 7035. Without swivel arm fixing device.

Specification	Length mm	kg	Art. no.
Double-jointed swivel arm	2 × 300	25	65.347.000

Module frames for swivel arm

Welded steel tube frame with perforations on four sides. Perforations at 50 mm increments, with steel axis for fixing onto the swivel arm. Load capacity 25 kg. Specification: sheet steel. Colour: light grey, RAL 7035.

Version with	Width mm	Height mm	Depth mm	Art. no.
1 rear panel	665	350	65	65.350.000
2 adjustable shelves*	665	350	265	65.351.000
2 swivel shelves	665	350	424	65.353.000
3 container strips	665	350	90	65.352.000

* Depth of adjustable shelf 200 mm.

Swivel shelves for swivel arm

Swivel shelves for swivel arm, with steel axis for fixing onto the swivel arm add-on, with stop bar on both sides. Tilt angle can be infinitely adjusted by up to 30°. Specification: sheet steel. Colour: light grey, RAL 7035.

Width mm	Depth mm	Height mm	kg	Art. no.
300	426	72	25	65.354.000

for module width mm **665**

W → Usable width mm 655

H ↑ Specification Art. no. 

200 plain **89.031.XXX**

350 plain **89.043.XXX**

500 plain **89.049.XXX**

200 perforated **89.025.XXX**

350 perforated **89.037.XXX**

500 perforated **89.113.XXX**

W → Usable width mm 660

H ↑ Art. no. 

85 **65.234.XXX**

Container size 2 3 4

Number of containers 6–12 6 4

W → Usable width mm 664

D ↗ Specification Art. no. 

200 plain **65.257.XXX**

300 plain **65.258.XXX**

350 plain **89.845.XXX**

400 plain **65.260.XXX**

200 slotted -

300 slotted **89.822.XXX**

350 slotted **89.828.XXX**

400 slotted **89.834.XXX**

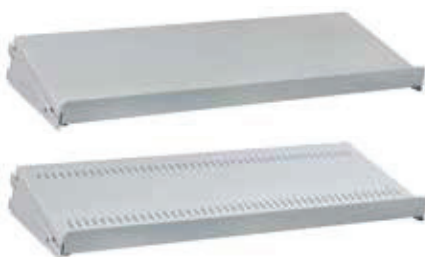
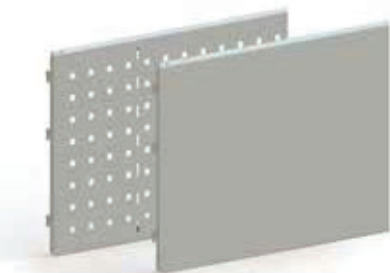

750			1000			1330			1500			2000		
740			990			1320			1490			1990		
Art. no.			Art. no.			Art. no.			Art. no.			Art. no.		
89.032.XXX			89.033.XXX			89.034.XXX			89.035.XXX			89.036.XXX		
89.044.XXX			89.045.XXX			89.046.XXX			89.047.XXX			89.048.XXX		
89.050.XXX			89.051.XXX			89.052.XXX			89.053.XXX			89.054.XXX		
89.026.XXX			89.027.XXX			89.028.XXX			89.029.XXX			89.030.XXX		
89.038.XXX			89.039.XXX			89.040.XXX			89.041.XXX			89.042.XXX		
89.114..XXX			89.115.XXX			89.116.XXX			89.117.XXX			89.118.XXX		
745			995			1325			1495			1995		
Art. no.			Art. no.			Art. no.			Art. no.			Art. no.		
89.460.XXX			65.085.XXX			65.235.XXX			89.461.XXX			89.462.XXX		
2	3	4	2	3	4	2	3	4	2	3	4	2	3	4
7-14	7	5	9-18	9	6	12-24	12	8	14-28	14	10	19-38	19	13
749			999			1329			1499			1999		
Art. no.			Art. no.			Art. no.			Art. no.			Art. no.		
89.840.XXX			65.261.XXX			65.263.XXX			89.841.XXX			89.842.XXX		
89.901.XXX			65.132.XXX			65.264.XXX			89.843.XXX			89.844.XXX		
89.902.XXX			89.903.XXX			89.846.XXX			89.847.XXX			89.848.XXX		
89.849.XXX			65.262.XXX			65.266.XXX			89.850.XXX			89.851.XXX		
-			-			-			-			-		
89.823.XXX			89.824.XXX			89.825.XXX			89.826.XXX			89.827.XXX		
89.829.XXX			89.830.XXX			89.831.XXX			89.832.XXX			89.833.XXX		
89.835.XXX			89.836.XXX			89.837.XXX			89.838.XXX			89.839.XXX		

» For keyhole hooks and storage containers see p. 162/163

Add-ons for perforated rear panels

Can be hooked into the slots on the rear panels. Storage shelf with stop bar at the front, 15 mm. Colour: black, NCS S 9000-N.

Specification	Width mm	Depth mm	Height mm	Art. no.
Additional rack	380	310	70	81.081.000
Spray can holder	380	74	70	81.083.000

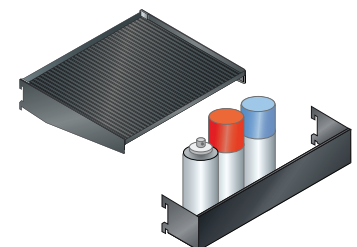

Dividers

For subdividing slotted adjustable shelves. Specification: sheet steel. Colour: as per colour chart. Sales unit: 10 pcs.

Depth mm	Height mm	Art. no.
300	100	50.103.XXX
300	150	50.104.XXX
300	200	50.105.XXX
350	100	50.106.XXX
350	150	50.107.XXX
350	200	50.108.XXX
400	100	50.109.XXX
400	150	50.110.XXX
400	200	50.111.XXX

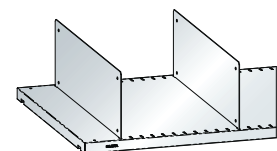

TFT monitor bracket and keyboard shelf

TFT monitor bracket for attaching flat screens with a VESA base plate. Hole pattern 75 × 75 mm and 100 × 100 mm, continuously adjustable tilt angle. Keyboard shelf for mounting on the monitor holder. Versions: sheet steel. Colour: Light grey, RAL 7035.

Specification for	Width mm	Height mm	Depth mm	Art. no.
Swivel arm	120	155	60	65.356.000
Keyboard support	600	155	200	65.357.000



Schematic diagram

The LED lighting and power supply system from LISTA meets the high requirements for modern and ergonomic workstations. The combined lamps and power strips make simple workstations functional system solutions for maximum ergonomics and cost-effectiveness. Good lighting and a tidy workstation are essential for high-quality, accurate work.

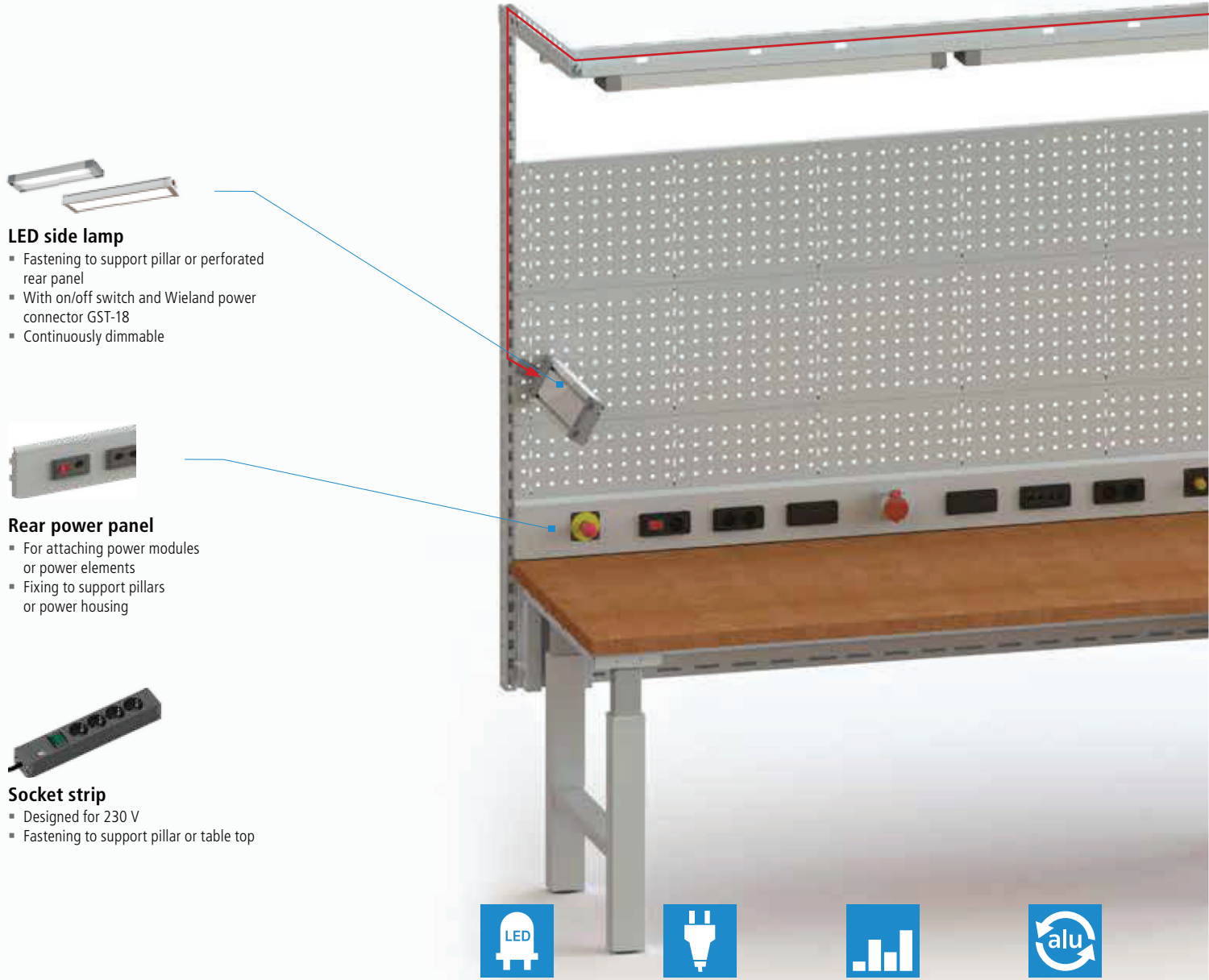

LED side lamp

- Fastening to support pillar or perforated rear panel
- With on/off switch and Wieland power connector GST-18
- Continuously dimmable

Rear power panel

- For attaching power modules or power elements
- Fixing to support pillars or power housing

Socket strip

- Designed for 230 V
- Fastening to support pillar or table top



LED technology
5000 K



GST-18
system plug



Continuously
dimmable



Aluminium
housing

Lighting

	LED technology 5000 K	GST-18 system plug	Continuously dimmable	Aluminium housing
LED Comfort +				
LED workstation lamp	●	●	●	●
LED side lamp	●	●	●	●
Articulated LED head lamp	●	-	●	●*
Articulated LED magnifier lamp	●	-	●	●*
LED Comfort				
LED workstation lamp	●	●	-	-
Side lamp	●	●	-	-

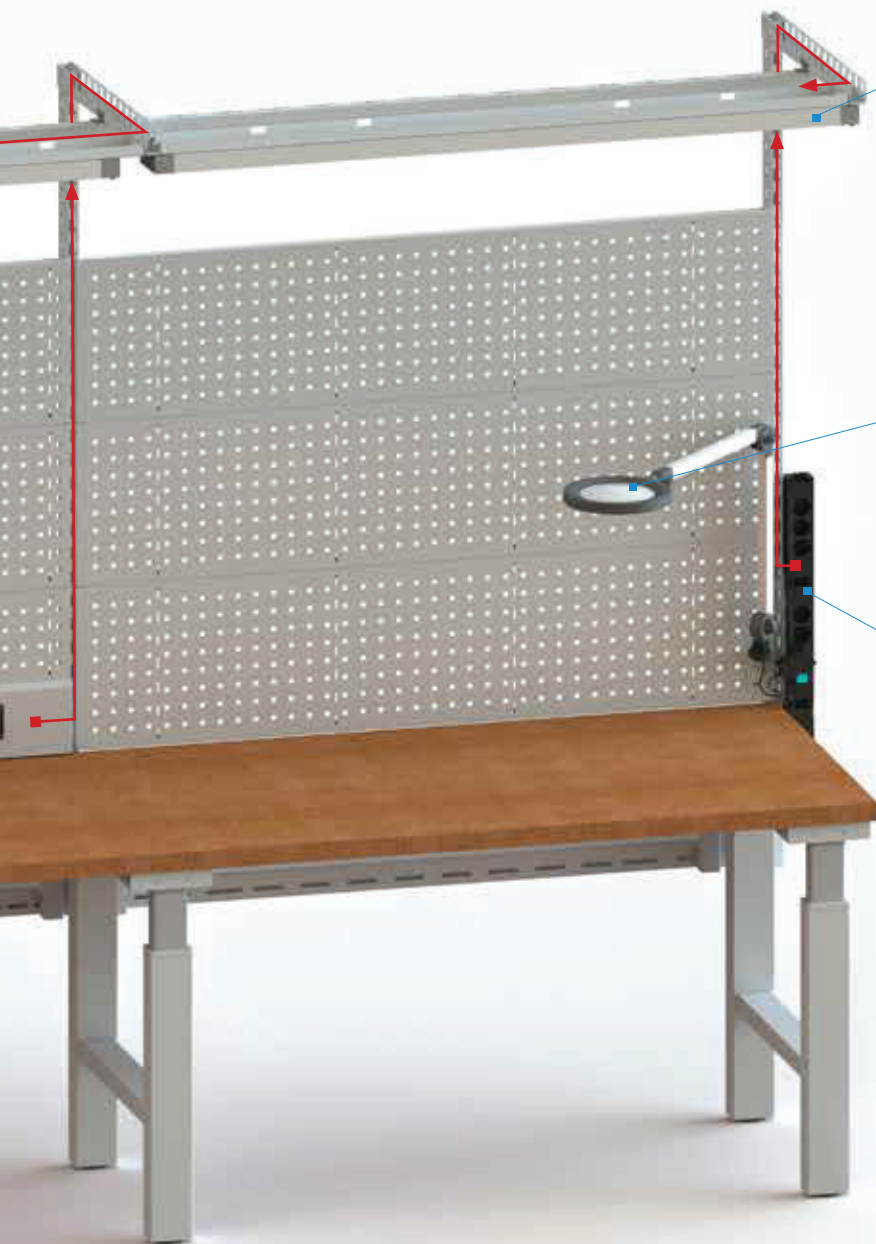

LED workstation lamp

- Fastening to lighting support
- With on/off switch and Wieland power connector GST-18



Articulated LED magnifier light or articulated LED head light

- Fastening to support pillar or table top
- With on/off switch
- Continuously dimmable



Power strips

- optionally with
- 3 × socket 230V
 - 3 × socket 230V and on/off switch
 - RCD

» For power modules/elements, see. p. 144–147



Power modules freely selectable



Freely selectable power elements



Integrated in rear panel



GST-18 system plug

Power supply

	Power modules freely selectable	Freely selectable power elements	Integrated in rear panel	GST-18 system plug
Rear power panel	●	●	●	●
Power enclosure	●	●	-	●
Power strips	-	-	-	●
Socket strip	-	-	-	-

Rear power panels and housings

**Please note:**

All power elements must be wired on site.

**Rear power panel**

For attaching power modules or power elements (see page 145). Simple, tool-free mounting on support pillars or power housing. A blind cover (89.543.000) is mandatory for unused fields. Height: 150 mm. Model: Colour as per colour chart.

**Power housing**

The solution for mounting without support pillars. Direct mounting on the countertop, incl. punch-out at the side and base. Height: 150 mm. Model: Sheet steel, colour: as per colour chart.

**Cable trough**

The cable tray is used to hold routing cables neatly. Depending on the module widths, the cable tray can be inserted without tools, similar to a rear panel. Height: 350 mm. Model: Sheet steel, colour: as per colour chart.



Module width mm

	665	750	1000	1330	1500	2000
	Art. no	Art. no	Art. no	Art. no	Art. no	Art. no
Rear power panel for power modules	89.014.XXX	89.015.XXX	89.016.XXX	89.017.XXX	89.018.XXX	89.019.XXX
Layout						
Number of power modules	2	3	4	5	6	8
Rear power panel for power modules and elements	-	-	-	-	89.020.XXX	89.021.XXX
Layout						
Number of power modules					4	6
Number of power elements					3	3
Housing	-	-	89.002.XXX	-	89.004.XXX	89.005.XXX
Cable trough	89.055.XXX	89.056.XXX	89.057.XXX	89.058.XXX	89.059.XXX	89.060.XXX

Power and connection cables

**System socket power cable**

Simple and quick electrical installation via 3-pin connector system. Length: 3 m.

Type	Art. no
CH	89.544.000
Schuko	89.545.000
FR	89.545.000
GB	89.546.000

**Intermediate coupling**

For interlinking power modules 1 – 4 and 6. Power modules which are not mounted next to one another are connected via a connection cable. Colour: black.

Type	Art. no
Type I	89.552.000
Type T	89.551.000
Type U	89.577.000

**Connection cable**

3-pin connector system with socket and plug.

Length m	Art. no
0.5	89.547.000
1	89.548.000
2	89.549.000
3	89.550.000

**Cable routing clip**

Set 8x	Art. no
	89.024.000

Power modules



Power module 1
1 × switch
1 × socket outlet 230 V



Power module 1 type CH
1 × overcurrent protection (thermal fuse 10A)
1 × switch



Power module 2
2 × socket 230 V



Power module 3
1 × single-pin circuit breaker, 16 A (CH: 10 A)



Power module 4
1 × FI safety switch 25 A/30 mA



Power module 6
Emergency stop button

	Art. no.	Art. no.	Art. no.	Art. no.	Art. no.	Art. no.
	-	-	-	-	89.541.000	89.540.000
CH (Type J)	-	89.598.000	89.530.000	89.579.000	-	-
Schuko (Type F)	89.535.000	-	89.531.000	89.542.000	-	-
FR (Type E)	89.536.000	-	89.532.000	89.542.000	-	-
GB (Type G)	89.537.000	-	89.533.000	-	-	-



Blind cover
for subsequent addition of power modules



Power module 7
2 × 2 RJ45 network sockets, without network cable, plug + play, cat 6



Power module 8
2 × DN7 compressed air connections, input: DN5 plug-in nipple, output: DN5 quick-release coupling



Power module 9
1 × socket outlet 230 V
2 × power USB



Power module 10
1 × socket outlet 230 V
1 × RJ45, without network cable, plug + play, cat 6



Power module 11
1 × overcurrent protection (thermal fuse 10A)
1 × socket outlet 230 V

	Art. no.	Art. no.	Art. no.	Art. no.	Art. no.	Art. no.
	89.543.000	89.538.000	89.539.000	-	-	-
CH (Type J)	-	-	-	89.389.000	89.388.000	89.595.000
Schuko (Type F)	-	-	-	89.385.000	89.381.000	-
FR (Type E)	-	-	-	89.386.000	89.382.000	-
GB (Type G)	-	-	-	89.387.000	89.383.000	-

Power elements



Emergency stop switch*
(Switching via the contactor)

89.100.000



400 V 16 A socket **

89.090.000



Compressed air connection*
(Compatible: RECTUS 25 / RECTUS 1600 / 1625 TEMA 1600, connection G 3/8")

89.105.000



Blind adapter plate

89.088.000



CEE 240 V socket*

CH	89.101.000
Schuko	89.102.000
FR	89.103.000
GB	89.104.000

* Incl. adapter plate ** Direct mounting, without adapter plate

When using the emergency stop switch, 400 V socket or CEE 240 V, a protective cover (Art. no. **89.107.000**) on the rear must be fitted on site.

Compressed air strip for support pillar

Compressed air strip for support pillar, with 2 compressed air boxes, inside diameter 7.2, and one coupling plug in the end cap. Including fastening material for support pillar. Specification: sheet steel. Colour: light grey, RAL 7035.

Connections Art. no.

2 × Compressed air
60 60 150 **65.281.000**



LED Comfort +

**LED workstation lamp**

The workstation lamp is mounted on the lighting support (see page 139). With On/Off switch and Wieland power connector GST-18. Infinitely dimmable. Glare suppression: structured screen. Colour temperature: neutral white 5000 K. Colour reproduction: Ra > 80. Description: aluminium housing, colourless anodised. Including fastening material. Excluding power and connecting cable (see page 144). A Waldmann development.

Length mm	Power W	Luminous flux lm	max. illuminance lx*	System connection GST-18	Installation	Art. no.
450	15	1100	499	Input	-	89.265.000
900	35	3000	1279	Input/Output	-	89.266.000
1500	63	5000	1770	Input/Output	-	89.267.000

**LED side lamp**

The side lamp can be mounted on the support pillar or perforated rear panels. With On/Off switch and Wieland power connector GST-18. Infinitely dimmable. Glare suppression: structured screen. Colour temperature: neutral white 5000 K. Colour reproduction: Ra > 80. Description: aluminium housing, colourless anodised. Including fastening material. Excluding power and connecting cable (see page 144). A Waldmann development.

Length mm	Power W	Luminous flux lm	max. illuminance lx*	System connection GST-18	Installation	Art. no.
450	15	1100	499	Input	right	89.268.000
450	15	1100	499	Input	left	89.269.000

**LED swing arm lamp**

The swing arm lamp can be mounted on the support pillar or any position on the table top. With On/Off switch. Infinitely dimmable. Glare suppression: structured screen. Colour temperature: neutral white 5000 K. Colour reproduction: Ra > 80. Arm length: 823 mm. Description: Plastic housing and articulated arms of colourless anodised aluminium. Including table clamp. Separate fixing bracket for mounting on support pillar. Colour: grey, **89.183.000**. Including 3 m cable; mains plug CEE 7/16 (Europlug), BS 1363 and NEMA 1-15P. A Waldmann development.

Length mm	Power W	Luminous flux lm	max. illuminance lx**	Ballast	Installation	Art. no.
360	14	1330	2604	100–240 V 50/60 Hz	-	89.270.000

**LED articulated arm magnifier lamp**

The articulated magnifier lamp can be mounted on the support pillar or any position on the table top. With On/Off switch. Infinitely dimmable. Colour temperature: neutral white 5000 K. Colour reproduction: Ra > 80. Arm length: 823 mm. Description: Plastic housing and articulated arms of colourless anodised aluminium. Including table clamp. Separate fixing bracket for mounting on support pillar. Colour: grey, **89.183.000**. Including 3 m cable; mains plug CEE 7/16 (Europlug), BS 1363 and NEMA 1-15P. A Waldmann development.

Magnifier	Dioptres	Power W	Luminous flux lm	max. illuminance lx***	Ballast	Art. no.
ø 160	3.5	15	-	7070	100–240 V 50/60 Hz	89.271.000

LED Comfort

**LED workstation lamp**

The workstation lamp is connected to the lighting support (see page 139). With On/Off switch and Wieland power connector GST-18. Colour temperature: neutral white 5000 K. Colour reproduction: Ra > 80. Description: PVC plastic housing, white including fastening material. Excluding power and connecting cable (see page 144).

Length mm	Power W	Luminous flux lm	max. illuminance lx*	System connection GST-18	Art. no.
450	10	1000	367	Input	89.272.000
900	30	3000	1073	Input/Output	89.273.000
1500	50	5000	1904	Input/Output	89.274.000

**LED side lamp**

The side lamp can be mounted on the support pillar or perforated rear panels. With On/Off switch and Wieland power connector GST-18. Colour temperature: neutral white 5000 K. Colour reproduction: Ra > 80. Description: PVC plastic housing, white including fastening material. Excluding power and connecting cable (see page 144).

Length mm	Power W	Luminous flux lm	max. illuminance lx*	System connection GST-18	Art. no.
450	10	1000	367	Input	89.275.000

**Magnetic bracket for Comfort+ and Comfort**

Practical accessories for attaching LISTA Comfort + and Comfort workstation lighting to or under the cabinets using a magnet. Contents: 4 enclosed magnets incl. fastening material

Magnet set	Art. no.
	89.262.000

*Measuring field: 100 × 100 cm/Measuring distance: 100 cm

**Measuring field: 100 × 100 cm/Measuring distance: 50 cm

***Measuring field: 30 × 30 cm/Measuring distance: 15 cm

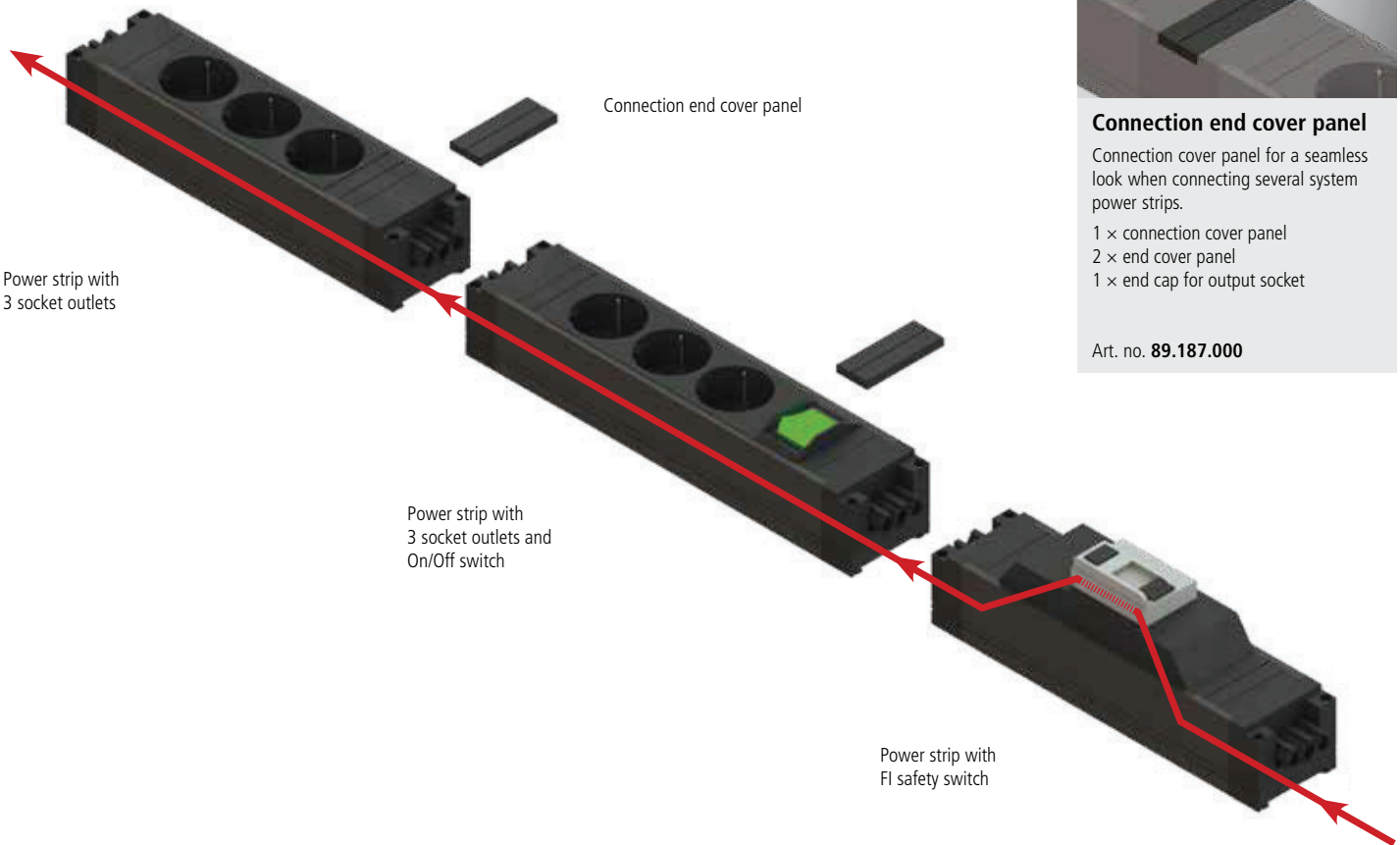

Connection end cover panel
 Connection cover panel for a seamless look when connecting several system power strips.
 1 × connection cover panel
 2 × end cover panel
 1 × end cap for output socket
 Art. no. **89.187.000**



System power strips

Input/output via system connector 230 V (Wieland system connector GST-18). System power strips can be directly connected to each other. CH version with thermal fuse 10 A. Description: plastic, black. Including fastening material for support pillar bracket. Excluding power and connecting cable, see page 144.

Description	Connector type	On/Off switch	Socket outlets	Art. no.
Power strip with socket outlets 230 V	D / PE	-	3	89.174.000
	CH	-	3	89.175.000
	F	-	3	89.176.000
	GB	-	3	89.177.000
Power strip with socket outlets 230 V and On/Off switch	D / PE	●****	3	89.178.000
	CH	●****	3	89.179.000
	F	●****	3	89.180.000
	GB	●****	3	89.181.000
Power strip with FI safety switch*****	via GST-18	-	-	89.182.000

Socket strip

Designed for 230 V. CH version with thermal fuse 10 A. Description: plastic, black. Including fastening material for workbench top and support pillar bracket. Including connecting cable, length 2m.

Description	Connector type	On/Off switch	Socket outlets	Art. no.
Socket strip with sockets 230 V	D / PE	●	4	89.170.000
	CH	●	4	89.171.000
	F	●	4	89.172.000
	GB	●	4	89.173.000

Hexagonal workbenches and vices

These space-saving hexagonal workbenches with vices are ideal as group workstations, especially for training centres. Every workstation has a large worktop and a drawer cabinet as substructure. The power outlets are integrated into the centre section.



+ **Wide range of specifications in a modular system**

for individual configuration and combination of drawer cabinets, power attachments and vices

+ **Maximum workstation utilisation**

ideal as group workstations for training facilities thanks to special design

+ **Perfect power supply**

thanks to the power attachment with freely configurable power elements and power modules, available as a single or double level attachment

+ **Easy assembly**

Power and compressed air connections are combined in the centre section and are very accessible thanks to the easily removable hexagonal cover plate

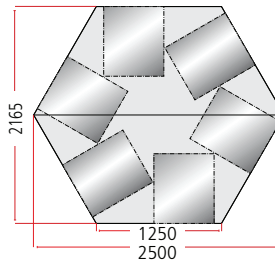

Hexagonal workbenches

With Multiplex top and 6 drawer cabinets, including pre-assembly and fastening material.

Multiplex top thickness	40 mm
Height of drawer cabinet	800 mm
Drawer cabinet width	564 mm
Drawer cabinet depth	725 mm
Drawer load capacity	75 kg

27 x 36 E

459 x 612 mm



W	D	H		kg	6 cabinets with number of drawers each mm	Lock	Art. no.
mm	mm	mm					
2500	2165	840	Multiplex	1500	4: 2 x 100 / 1 x 200 / 1 x 300	KEY Lock	89.200.XXX
2500	2165	840	Multiplex	1500	5: 1 x 50 / 2 x 100 / 1 x 150 / 1 x 300	KEY Lock	89.201.XXX



Power attachment module

in double-decker version

For power modules/elements, see p. 145



Hexagonal power attachment covers

For attaching power modules or power elements (see page 145). 6 attachment covers are required in each case; here you can freely choose between the two variants.

Edge length mm	H	Number of power modules	Number of power elements	Art. no.
mm	mm			
620	155	2	-	89.080.XXX
620	155	1	2	89.081.XXX



Hexagonal cover plate

Multiplex 20 mm, incl. grooved recess for attaching and securing the power attachment covers.

Edge length mm	Art. no.
531	89.083.000



When ordering a workbench from these two pages with **CODE Lock**, please add the suffix "**C**" or for **RFID** or **AUTO Lock** "**F**" or "**A**" in addition to the article number from the table (e.g. **78.897.XXX.C**).

Locking systems see pp. 28–31



"Gressel" vice system

Forward-opening vice with off-centre design enables vertical clamping of up to 4 inch round stock. With protected square guide, for maintenance-free precision. Unlimited applications thanks to the patented 90° swivelling clamp. Anvil and saddle aids enable optimum machining of pipes and other work pieces. Specification: spheroidal graphite iron, with two exchangeable hewn jaws, fastening material included. Colour: stationary elements dust grey, RAL 7037, movable elements cobalt blue, RAL 5013.

Specification	Opening of jaws mm	Jaw width mm	Art. no.
Gressel AX 100	110	100	39.983.000
Gressel AX 125	135	125	39.984.000
Gressel AX 160	170	160	39.985.000

"Heuer" vice system

Forward-opening vice for vertical clamping of round material, centrally adjustable guides, forged tube jaws and strong anvil as well as fixed jaws. Proven double prismatic guide prevents dirt and damage. Two-year guarantee. Specification: drop-forged steel, surface-hardened fixed jaws, Spindle completely galvanised, including fastening material. Colour: Anthracite grey, RAL 7016

Specification	Opening of jaws mm	Jaw width mm	Art. no.
Heuer 100120	150	120	44.990.000
Heuer 100140	200	140	44.991.000

Pre-assembly of "Gressel" and "Heuer" vice

Pre-assembly (holes) excluding fastening material.

Position pre-assembly	Art. no.
left	44.131.000
centre	44.132.000
right	44.133.000

Note
With workbench tops not made of solid wood (e.g. Urphen, resin), vice underlays are mandatory (on request).



Vice cabinet on request.



Vi kan skreddersy innredningen til ditt behov.

Vi står disponible til å bistå i deres prosjekter.

*3D tegninger.

*Oppmålinger.

*Kartlegging av behov.

*Montasje.

Ta gjerne kontakt med oss om du har et behov som ikke finnes i katalogen.



Lista ble grunnlagt i 1945

Hovedkontoret ligger i Sveits.



Produksjonen foregår i Sveits og Tyskland.



Kontaktinfo:

Ing Yngve Ege AS

Postadresse:
Postboks 1 Sentrum
0101 Oslo

Besøksadresse:
Ryenstubben 5
0679 Oslo

Tel: 23 24 10 00
Fax: 23 24 10 01

ege@ege.no

Produktansvarlig.

Navn:

Telefon:

Epost: